

# Accuphase

CLASS-A STEREO POWER AMPLIFIER

## A-50V

● Pure class-A drive delivers high-quality power: 50 watts x 2 into 8 ohms ● Output stage with 10 parallel push-pull power MOS-FETs assures power linearity down to ultra-low impedance load, with 400 watts x 2 into 1 ohm ● Current feedback circuit topology assures great sound and stable operation ● Bridged use of two units possible for four times the output power ● Large toroidal "Super Ring" power transformer





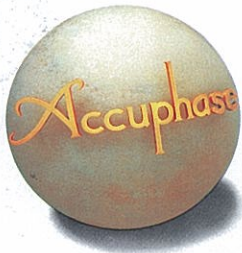

**The peerless sound of pure class-A — Power MOS-FETs in the output stage with a 10-parallel push-pull configuration perform extremely low output impedance and realize constant-voltage drive for perfect speaker control. Linear power progression ranges from 50 watts into 8 ohms to 400 watts into 1 ohm in stereo operation. Current feedback circuit topology assures great sound and operation stability.**

The mono power amplifier M-2000 was widely acclaimed as an impressive blend of performance and sound quality thanks to the realization of two major principles: very low output impedance (Note 1), and constant drive voltage (Note 2).

The A-50V is a stereo power amplifier based on the same design technology as the M-2000. It uses MOS-FET devices selected for their musical qualities which are driven in a no-holds-barred class-A circuit configuration. The amplifier brings out even the most delicate nuances in the source with full authority. This is Accuphase sound at its very best.

Pure class-A operation means that the circuit always draws the same amount of power from the power supply, regardless of the presence or absence of a music signal. It is impervious against external influences and has high stability. The output stage produces considerable amounts of thermal energy, but in the A-50V this is dissipated by extra-large heat sinks for the left and right channels, to prevent the possibility of problems caused by internal heat buildup.

Current feedback topology ensures good phase characteristics in the upper frequency range, combining operation stability with excellent frequency response. The MOS-FET devices in the output stage are renowned for their high reliability paired with favorable sonic properties. The amplifier has outstanding power linearity realized even at extremely low impedance loads, as illustrated by the power rating that extends from 50 watts into 8 ohms to 400 watts into 1 ohm. The muscle for this kind of performance comes from an ultra-efficient Super Ring type toroidal power transformer of massive proportions, complemented by ample filtering capacity.

Balanced inputs shut out externally induced noise. Gold-plating of circuit traces, input/output connectors, and all other major signal-carrying parts ensures total sonic purity. Bridged operation mode turns the unit into a monaural amplifier with even more power.

**Note 1: The reasoning for low amplifier output impedance**

The load of a power amplifier, namely the loudspeaker, generates a counter-electromotive force that can flow back into the amplifier via the NF loop. This phenomenon is influenced by fluctuations in speaker impedance, and interferes with the drive performance of the amplifier. The output impedance of a power amplifier should therefore be made as low as possible by using output devices with high current capability. This absorbs the counter-electromotive force generated by the voice coil and prevents the occurrence of intermodulation distortion.

**Note 2: The constant drive voltage principle**

Even in the presence of a load with wildly fluctuating impedance, the ideal power amplifier should deliver a constant voltage signal to the load. When the supplied voltage remains constant for any impedance, output power will be inversely proportional to the impedance of the load. A conventional amplifier can be easily made to operate in this way down to a load impedance of about 4 ohms. At 1 ohm, however, eight times the output of an 8-ohm load is called for, which can only be sustained by an extremely well designed and capable output stage and a highly robust and powerful power supply section. To build such an amplifier is a task that requires not only considerable experience and resources but also a thorough rethinking of basic principles.

**Power MOS-FET output stage in 10-parallel push-pull configuration delivers 400 watts into 1 ohm, 200 watts into 2 ohms, 100 watts into 4 ohms, or 50 watts into 8 ohms with outstanding linearity**

The output stage (Figure 1) uses power MOS-FETs with negative thermal characteristics. 10 pairs of these devices are arranged in a



parallel push-pull configuration for each channel. The result is stable operation with ideal power linearity even at ultra-low impedance load. The maximum power dissipation of one MOS-FET is 120 watts, but the actual power load per pair is only 5 watts, so that each device is driven only in its low-power range where linearity is excellent. The drive stage also uses power MOS-FETs, in a cascode connection that gives wide frequency response and requires only small amounts of negative feedback. This also contributes to sound quality.

Figure 2 shows the output voltage/current characteristics at various impedance loads. Output voltage is almost constant at various loads, which means that current increases linearly.

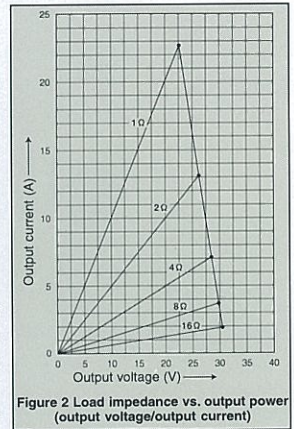

Figure 2 Load impedance vs. output power (output voltage/output current)

**Current feedback topology prevents phase shifts**

The amplifying circuits in the A-50V use the cur-

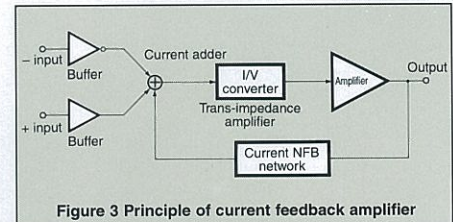

Figure 3 Principle of current feedback amplifier

rent feedback principle for negative feedback. At the input point of the feedback loop, the impedance is kept low and current

detection is performed. A trans-impedance amplifier then converts the current into a voltage to be used as the feedback signal. Since the impedance at the current feedback point (current adder in Figure 3) is very low, there is almost no phase shift. Phase compensation therefore can be kept at a minimum. A minimal amount of NFB results in

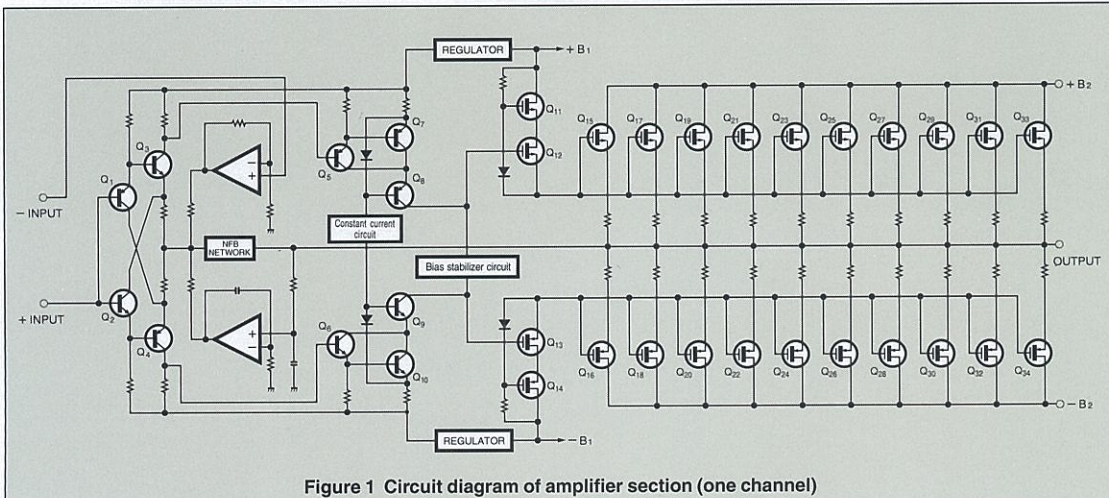

Figure 1 Circuit diagram of amplifier section (one channel)

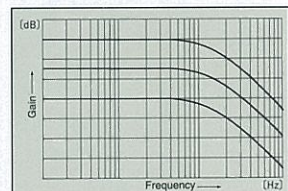

Figure 4 Frequency response with current feedback (response remains uniform also when gain changes)



maximum improvement of circuit parameters. The result is excellent transient response and superb sonic transparency, coupled with utterly natural energy balance. Figure 4 shows frequency response for different gain settings of the current feedback amplifier. The graphs demonstrate that response remains uniform over a wide range.

**Bridged operation mode creates a true monophonic amplifier with 800 watts into 2 ohms, 400 watts into 4 ohms, or 200 watts into 8 ohms**

Bridged mode means that the two channels of an amplifier are driven with the same signal volt-

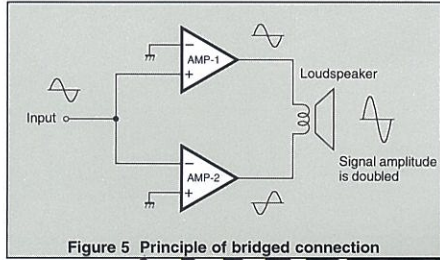

Figure 5 Principle of bridged connection

age but with opposite phase, and their output is combined. The A-50V provides a switch arrangement for bridged operation, which turns the unit into a high-grade monaural amplifier capable of delivering even more stunning amounts of power.



**Balanced connection reliably blocks induced noise**

The balanced connection principle makes use of the fact that induced noise in two cable leads will be of the same phase. By combining the signals at the receiving end, the noise is canceled out and only the pure signal remains. The longer the cable connections between audio components, the greater is the danger of external noise being introduced into the signal path. Balanced connection keeps the signal transfer completely free from any kind of interference.

**All signal paths gold-plated**  
High-purity copper is commonly used in audio components for signal path lines. The A-50V goes one step further by providing gold-plating for printed circuit board traces as well as for the

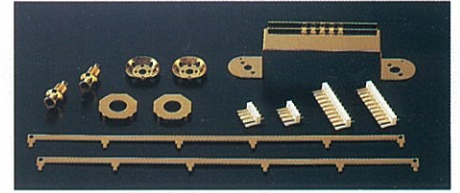

input jacks and speaker terminals. This approach results in a distinct sonic improvement.

**Extra-large speaker terminals**  
The oversize speaker terminals accommodate even very heavy-gauge speaker cable. The terminals are made of extruded high-purity brass and are gold-plated for utmost reliability and minimum contact resistance. Molded caps are provided to assure proper insulation.



■ Power amplifier assembly with 10 parallel push-pull MOS-FETs (total 40 devices for left and right channel) and current feedback amplifier circuitry mounted directly to massive aluminum diecast heat sinks



**Robust power supply with aluminum enclosed "Super Ring" toroidal transformer and high filtering capacity**

The power supply section is a critical aspect of any power amplifier. The A-50V features a large toroidal power transformer with a rating of 1,000 VA. The transformer is housed in a non-resonant aluminum enclosure filled with damping material that has excellent heat transfer characteristics. Toroidal transformers which use heavy-gauge copper wiring on a ring-shaped core have various advantages, such as very low impedance, small size, and high conversion efficiency. The "Super Ring" type transformer used by Accuphase is ideally



suited for audio applications. It has the following characteristics:

- ① Near-circular core caliber allows near-circular coil windings with high packing density, resulting in low leakage flux and minimum vibrations.
- ② Smaller ferrite core diameter and copper windings with high specific gravity mean low ferrite losses and low inrush current.

Two extra-large 82,000 µF aluminum electrolytic capacitors provide more than ample power supply capacity.

**Digital power meter shows true output levels**  
Output power is indicated by a digital meter. The meter circuit senses the actual voltage and current levels delivered to the speaker. An analog multiplier circuit calculates the power for any given moment, which is then precisely displayed on the digital meter. Since



the level of a musical signal normally fluctuates rapidly, power output would be difficult to read precisely with an analog meter. The digital circuit also takes the complex speaker impedance into consideration, providing an indication of true power at any time. The hold time of the display can be switched between 1 second and infinite. When the power indication is not required, the meters can also be switched off.

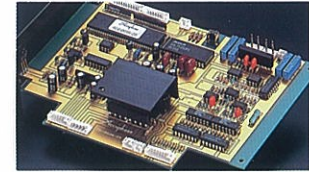

Assembly with protection circuitry etc.

High-quality parts assure outstanding reliability



**Front Panel**

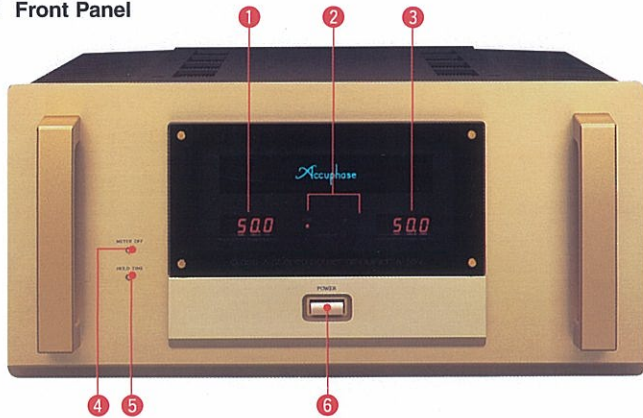

**Rear Panel**

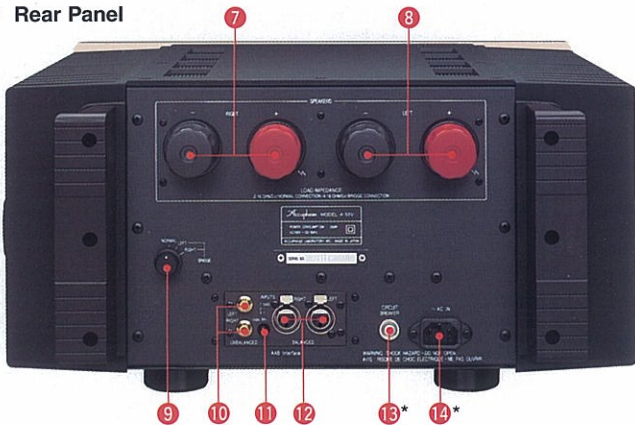

- |                                                                        |                                                                             |
|------------------------------------------------------------------------|-----------------------------------------------------------------------------|
| ① Left-Channel Digital Power Meter                                     | ⑩ Unbalanced Inputs                                                         |
| ② Hold-Time Indicator 1 SEC/∞                                          | ⑪ Input Selector<br>UNBALANCED BALANCED                                     |
| ③ Right-Channel Digital Power Meter                                    | ⑫ Balanced Input Connector<br>① GND<br>② Inverted [-]<br>③ Non-inverted [+] |
| ④ Meter Operation Switch ON OFF                                        | ⑬ AC Circuit Breaker*                                                       |
| ⑤ Hold-Time Selector 1 SEC/∞                                           | ⑭ AC Input Connector<br>[for supplied power cord]*                          |
| ⑥ Power Switch                                                         |                                                                             |
| ⑦ Right-Channel Speaker Output Terminals                               |                                                                             |
| ⑧ Left-Channel Speaker Output Terminals                                |                                                                             |
| ⑨ Normal/Bridged Operation Selector<br>NORMAL BRIDGE LEFT BRIDGE RIGHT |                                                                             |

**Remarks**  
\* The shape of the plug of the supplied power cord, and the circuit breaker current rating depend on the voltage rating and destination country.

● Specifications and design subject to change without notice for improvements.

**GUARANTEED SPECIFICATIONS**

[Guaranteed specifications are measured according to EIA standard RS-490.]

**Rated Continuous Average Output (20 to 20,000 Hz)**

Stereo mode (both channels driven)  
400 watts per channel into 1-ohm load\*  
200 watts per channel into 2-ohm load  
100 watts per channel into 4-ohm load  
50 watts per channel into 8-ohm load

Monophonic mode (bridge connection)  
800 watts per channel into 2-ohm load\*  
400 watts per channel into 4-ohm load  
200 watts per channel into 8-ohm load

\* Only audio signal

**Total Harmonic Distortion**

Stereo mode  
0.05% with 2-ohm load  
0.03% with 4- to 16-ohm load

Monophonic mode  
0.03% with 4- to 16-ohm load

**Intermodulation Distortion**

0.003%

**Frequency Response**

20 to 20,000 Hz, +0 dB, -0.2 dB  
(for rated continuous average output)  
0.5 to 150,000 Hz, +0 dB, -3.0 dB  
(for 1 watt output)

**Gain**

28.0 dB (in both stereo and monophonic mode)

**Output Load Impedance**

1 to 16 ohms in stereo mode  
2 to 16 ohms in monophonic mode

**Damping factor**

100 in both stereo and monophonic mode

**Input Sensitivity (with 8-ohm load)**

Stereo mode  
0.80 V (for rated continuous average output)  
0.11 V (for 1 watt output)

Monophonic mode  
1.59 V (for rated continuous average output)  
0.11 V (for 1 watt output)

**Input Impedance**

Balanced: 40 kohms  
Unbalanced: 20 kohms

**Signal-to-Noise Ratio (A-weighted)**

110 dB (input short circuited, rated continuous average output)

**Digital Output Meter**

Type: True power value display type  
Display range: 0.1 to 400.0 watts in stereo mode  
1 to 2,000 watts in monophonic mode  
Hold time: 1 sec. or ∞ (selectable)  
Display off function provided

**Power Requirements**

100 V, 120 V, 220 V, 230 V, 240 V  
(Voltage as indicated on rear panel) AC, 50/60Hz

**Power Consumption**

310 watts at zero signal input  
550 watts in accordance with IEC-65

**Maximum Dimensions**

Width: 475 mm (18-11/16")  
Height: 239 mm (9-7/16")  
Depth: 545 mm (21-7/16")

**Weight**

45.1 kg (101.2 lbs.) net  
55.0 kg (121.3 lbs.) in shipping carton



ACCUPHASE LABORATORY INC.

PRINTED IN JAPAN L9810Y 950-0157-00 (AD1)