

# Accuphase

## STEREO PREAMPLIFIER

# C-270

- Class-A cascode push-pull circuits on all stages, DC servo directly coupled
- Unit amps stabilized by dedicated constant-voltage circuits
- Balanced inputs and outputs provided





# Accuphase C-270



- 1 On the mother board, unit amps, filter capacitor, and rectifier are mounted.
- 2 L-channel high-level amp unit
- 3 L-channel balanced input and output amp unit

- 4 L-channel equalizer amp unit
- 5 R-channel high-level amp unit.
- 6 R-channel balanced input and output amp unit
- 7 R-channel equalizer amp unit

Recent years have seen amazing, rapid progress in the technologies of digital tape recorders and compact disc players so that various high quality program sources may be enjoyed.

The improved quality of such things as program sources, CDs, turntables, and tape recorders accordingly calls for parallel improvements in reproduction devices, especially preamplifiers, since they are chiefly responsible for the quality of the reproduced sounds. In addition, recent diversification of program sources requires that preamplifiers be able to input various signal sources and offer superb operability.

Accuphase's C-270 stereo preamplifier inherits all the tested qualities of the C-280 that received a most favorable response from all over the world. The C-270 is a preamplifier that opens a new era, being provided with an equalizer amplifier whose characteristics have been improved to the virtual upper limit and a high-level flat amplifier with balanced input and output. While it does not have a built-in head amplifier, the C-270 has no fewer than 10 input systems to cope with a diversity of program sources. Its amplifier circuit has direct-coupled cascode push-pull circuits at all stages, which is the ideal construction. The characteristics of this amplifier circuit are stabilized by two independent transformers, independent coils for each unit amplifier, and a dedicated constant-voltage power supply. This extravagant attention to engineer-

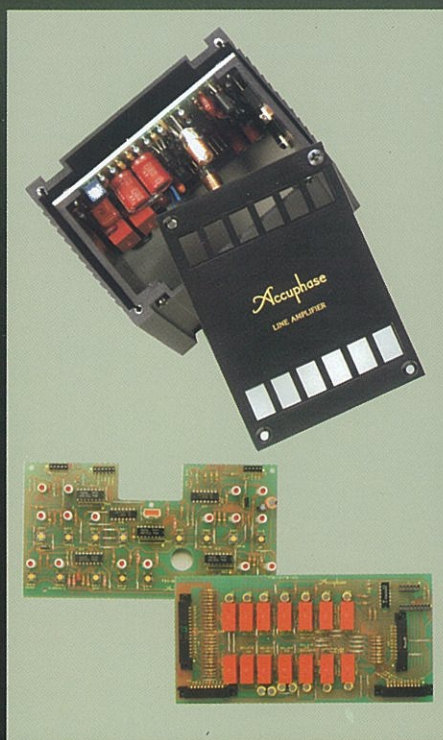

ing detail reflects the importance Accuphase attaches to reproduced sound that faithfully conveys the sound quality of the original sound field.

One of the 10 pairs of input lines is for balanced input and comes with XLR connectors for connection to devices with balanced output. This allows signals to be transferred with no quality loss and with no adverse effects from wiring cable noise. In addition to the 10 inputs, the C-270 has three outputs of which one is of balanced type.

Each unit amplifier is housed in a relatively thick aluminum housing that acts as a noise shield from external sources and also protects against malfunctions caused by vibration. The input and output terminals are finished with high-grade rhodium plating, offering excellent mechanical durability and resistivity to corrosion for long contact reliability. The other design features – the rigid construction employing a mother PC board of glass epoxy with metal frame, the distinctive, gold-finished, scratched-hairline panel made of thick aluminum plate, the large control knobs, the persimmon sideboards, etc. – are the rich extras that Accuphase adds on top of the best sound technology. We aim for no less than total owner satisfaction.

Here's what Accuphase offers in this classic piece of audio engineering:



# Class-A Cascode Push-Pull Configuration at Every Stage. DC Unit Amps Stabilized by Dedicated Constant-Voltage Circuit.

1

## CLASS-A CASCODE PUSH-PULL CIRCUITS AT ALL STAGES IMPROVE HIGH-FREQUENCY CHARACTERISTICS, LINEARITY, AND SIGNAL-TO-NOISE RATIO

Fig. 1 is the circuit diagram of the equalizer amplifier and high-level amplifier. This ideal amplifier circuit consists of a cascode amplifier and Class-A push-pull circuits at every stage, an Accuphase tradition. This further improves desirable amplifier characteristics to the utmost limits before negative feedback (NFB) is performed. The cascode amplifier consists of two elements (transistors) vertically connected so that the two elements operate as one. This arrangement increases the input impedance and gain and simultaneously enhances the high-frequency characteristics. In addition, linearity is maintained until the operating limit of the elements is reached, resulting in decreased distortion, improved signal-to-noise ratio, and realization of the ideal characteristics of an amplifier circuit. The Class-A push-pull circuitry further improves the characteristics.

The diagram in Fig. 1 may give you the impression that the circuit is quite complicated. However, it basically consists of only three stages: 1) the "cascode push-pull differential amplification stage" (transistors Q1 to Q11), 2) the driver stage (transistors Q12 to Q15), and 3) the output stage (transistors Q16 to Q21). These three stages assure high circuit stability.

2

## DC SERVO CONTROL IN ALL UNIT AMPS PERMITS STRAIGHT DC OPERATION FROM AD (ANALOG DISC=LP) INPUT TO FINAL OUTPUT

The IC in Fig. 1 is the "DC servo circuit" that keeps the output signal to the zero potential by detecting and feeding back to the input the DC component generated in the output. In other words, it prevents DC drift. The IC enables direct coupling of all the signals from the analog disc (LP) input to the output and thus helps produce high quality sound that carries no trace of coloration.

3

## 10 INPUTS AND 3 OUTPUTS

Lately there has been a growing demand for audio systems that can be connected even to video equipment. This demand naturally applies to preamplifiers, hence it is mandatory that a preamplifier be provided with multiple input systems.

Accuphase has responded by providing the C-270 with 10 inputs. Four are line inputs while the others are for analog disc input, tuner input, CD input, and two tape recorders. In addition, the C-270 is the first preamplifier to be provided with a CD balanced input so that equipment with balanced output, such as CDs, can be connected. The preamplifier is also provided with two unbalanced outputs and one balanced output. This is highly convenient for driving more than one power amplifier at the same time.

Balanced transmission is a transmission system widely used in broadcast and studio equipment. The operating principle of this transmis-

sion system is shown in Fig. 2. In this system, the sender generates positive and negative output signals, each of which has the same potential as the other but is out of phase by 180 degrees. These two output signals are transmitted along a three-core cable. The ground line in the figure only connects the zero potential of the signals and therefore carries no signal current. The receiver, in turn, receives these sent signals, mixing them with a positive and negative amplifier. Since the noise picked up by both signals are in phase when input to the two amplifiers, they act to cancel each other out. As a result, only pure signals are input to the amplifiers to be reproduced.

4

## TWIN MONO-CONSTRUCTED INDEPENDENT POWER TRANSFORMERS; EACH UNIT AMPLIFIER HAS AN EXCLUSIVE POWER SUPPLY

Since a signal is generated from a power source and then returned to it, a power supply circuit can also be considered part of the amplifier circuit. Therefore, the quality of the power supply circuit must match that of the amplifier circuit. Moreover, the higher the gain of a preamplifier, the higher the quality must be of the power supply circuit. If the power supply circuit is inferior, it significantly degrades the quality of the overall preamp.

The C-270 is equipped with two power transformers which are respectively dedicated to the left and right channels. Each unit amp has its exclusive secondary coil. Moreover, to obtain pure and powerful current, a "multiple power supply system" is employed by which power is supplied via a constant-voltage power supply circuit dedicated to each unit amplifier. Fig. 3 shows the circuit diagram of this system. As can be seen, the rectifiers and filter capacitors are placed near the transformers. However, because constant-voltage power supply circuits are accommodated in the housing along with the unit amplifiers, the source impedance can be kept low. This means the signals are stably and faithfully amplified.

5

## LOGIC CONTROL RELAYS TO SHORTEN SIGNAL PATHS

Routing around a long signal path for switching the input line or for monitoring tapes can degrade the high-frequency characteristics. For

this reason, it is best to have the signal path as straight and short as possible. In the C-270, therefore, relays are placed at the points of the signal path where a switch is necessary. These relays are electronically controlled by logic circuits.

Obviously, the quality of the relays is a key factor in such a system. Therefore, the C-270 employs sealed relays especially developed for audio applications. They have bifurcated cross-bar contacts, low contact resistance, and high durability.

6

## EQUALIZER AMP STRESSING UNIQUE ATMOSPHERE OF ANALOG DISC (LP)

The basic circuit configuration of the equalizer amplifier is shown in Fig. 1. Since the level of the signals to be processed is very weak, they are easily affected by inherent noise. Therefore, low-noise field effect transistors (FETs) are carefully selected for the input.

As well as the circuit configuration, the RIAA network formed by resistors and capacitors determines the sound quality of an audio system. The C-270 employs noninductive capacitors which were especially developed for audio applications and thus inductive effect is reduced to a minimum. These capacitors provide excellent characteristics outside the audible frequency range and use epoxy resin as the dielectric to prevent self-vibration that may be generated by signal voltage. The C-270 can therefore reproduce the subtle atmosphere peculiar to analog discs. As the feedback resistors, extremely precise, gold-foil, resistors are adopted. Their values hardly change with temperature so that high stability and quality of the reproduced sounds are reliably achieved.

7

## RIGID ALUMINUM HOUSING ACCOMMODATING AMPLIFIER CIRCUITS AND CONSTANT-VOLTAGE POWER SUPPLY

The six amplifiers on the left and right channels, including the balanced amplifiers, and the constant-voltage power circuit are accommodated in a relatively thick, rigid aluminum housing to shield induction. This housing serves as well to reduce the effects of vibration, since the printed circuit board is securely fixed to the housing with screws.

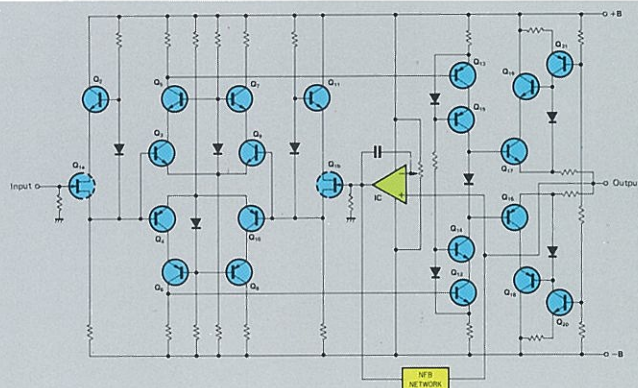

Fig. 1 Basic Diagram of Unit Amplifier



# vo Direct-Coupled. Two Independent Transformers.

## anced Input and Output Circuits for Pure Signal Transfer

### 8 COMPLETE FUNCTIONS FOR RECORDING, PLAYBACK, AND DUBBING

In addition to two pairs of input/output jacks for tape recorders, a tape monitoring function is also provided. The C-270 is also equipped with "TAPE COPY" switches that allow dubbing between two tape recorders.

### 9 THREE-STEP ATTENUATOR

Attenuation control is convenient when starting off record play, searching for tape positions, or temporarily muting the volume level. The C-270 has three attenuation selector switches that attenuate the volume by -20dB, -30dB, or  $-\infty$  (the volume is completely turned down).

### 10 RHODIUM-FINISHED HIGH QUALITY INPUT/OUTPUT JACKS

Avoiding soft plating materials in finishing often-used input/output jacks is important because their contacts may soon show wear, leading to eventual exposure of the substrate. This can lead to corrosion and the adverse effects of a poor contact. While rhodium plating is more expensive than gold plating, it is widely used for connectors of communications equipment and computers because of its highly valued durability. Its hardness especially has no comparison, having been shown in testing to be capable of withstanding 100 million instances of sliding with a plating thickness of only 1  $\mu\text{m}$ . Moreover, it offers long-term contact reliability and excellent resistivity to corrosion.

### 11 OTHER FUNCTIONS

There are still other impressive features to add to those already presented. The C-270 also has a **compensator** that balances the energy and automatically controls the increment in the volume according to the position of the VOLUME control. It does this by raising the frequency

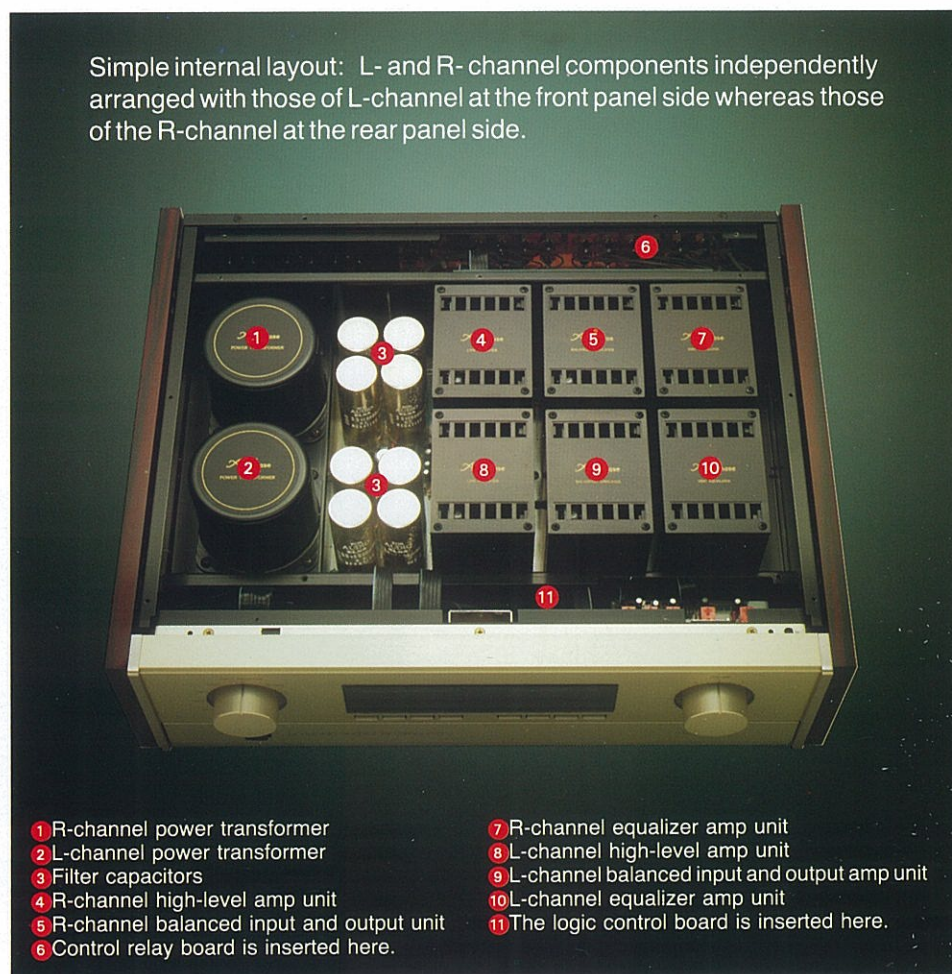

when the volume is insufficient. The **subsonic filter** cuts off unwanted low-frequency noise which may be generated outside the audio frequency range. The **mode switch** permits checking the balance of the speakers by setting the monophonic mode. And for monitoring purposes, the **headphone jack** comes in handy.

As you can see, the C-270, despite its simple appearance, has abundant functions.

### 12 PERSIMMON SIDEBOARDS

The C-270 is beautiful both inside and out. Sporting a gold-finished panel and encased elegantly in persimmon-finish wood, it has a commanding appearance that adds dignity and decor to any listening room.

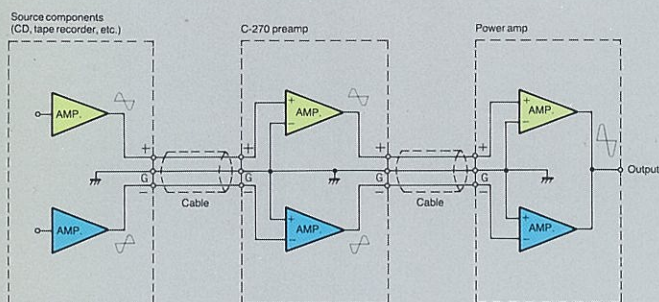

Fig. 2 Principle of Balanced Type Network

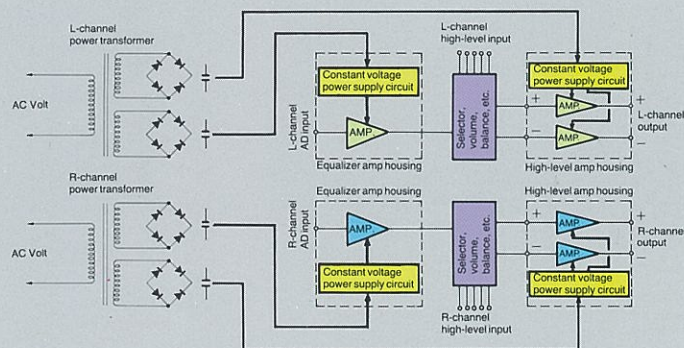
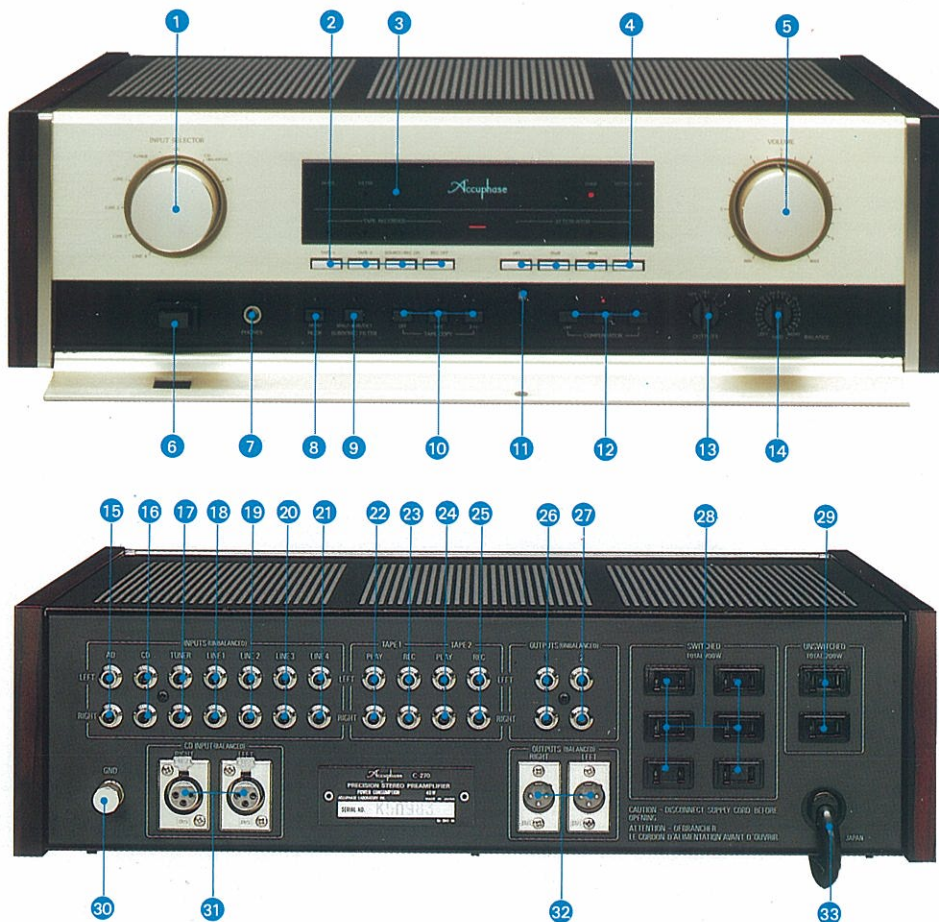

Fig. 3 Multiple Power Supply Method





**1 INPUT SELECTOR**

LINE 4, LINE 3, LINE 2, LINE 1, TUNER, CD, CD(BALANCED), AD

**2 ON/OFF switch of TAPE REcording output**  
REC OFF, SOURCE/REC ON, TAPE 2, TAPE 1

**3 Operation indicator LEDs**  
Power ON/OFF, muting, STEREO/MONO, FILTER ON/OFF, COMPENSATOR ON/OFF, OUTPUT ON/OFF, TAPE RECORDER, ATTENUATOR

**4 ATTENUATOR**  
-∞, OFF, -20 dB, -30 dB

**5 VOLUME level control**

**6 POWER switch**  
Headphone jack

**7 MODE switch**  
STEREO/MONO

**8 SUBSONIC FILTER**  
10 Hz, -18 dB/oct

**9 TAPE COPY switch**  
OFF, 1→2, 2→1

**10 Magnet catch for subpanel**

**11 Loudness COMPENSATOR**  
OFF, 1, 2

**12 Output selector**  
OFF, 1&2, 1, 2

**13 Volume BALANCE control**

**14 AD (Analog Disc) input jacks**

**15 CD (Compact Disc) input jacks**

**16 TUNER input jacks**

**17 LINE 1 input jacks**

**18 LINE 2 input jacks**

**19 LINE 3 input jacks**

**20 LINE 4 input jacks**

**21 TAPE 1 PLAYback input jacks**

**22 TAPE 1 REcording output jacks**

**23 TAPE 2 PLAYback input jacks**

**24 TAPE 2 REcording output jacks**

**25 OUTPUT jacks (unbalanced/1 Ω)**

**26 OUTPUT jacks (unbalanced/1 Ω)**

**27 AC outlets (SWITCHED)\***

**28 AC outlet (UNSWITCHED)\***

**29 GROUND terminal**  
(equivalent to XLR-3-31 connectors)

**30 CD INPUT (BALANCED) connectors**  
(equivalent to XLR-3-31 connectors)

**31 OUTPUT (BALANCED) connectors**  
(equivalent to XLR-3-32 connectors)

**32 Power cord**

\* The switched and unswitched outlets may not be supplied depending on the safety standards or regulations applicable in the particular country to where the unit is destined.

**GUARANTY SPECIFICATIONS**

**FREQUENCY RESPONSE**

TUNER, CD, LINE, TAPE PLAY INPUTS:  
1.0 to 500,000 Hz: +0, -3.0 dB  
20 to 20,000 Hz: +0, -0.2 dB  
AD INPUT:  
20 to 20,000 Hz: +0, -0.2 dB

**TOTAL HARMONIC DISTORTION**

Will not exceed 0.005% at rated output level, 20 Hz to 20,000 Hz.

**INPUT SENSITIVITY AND IMPEDANCE**

Input terminal	Sensitivity		Impedance
	Rated output	EIA standard (0.5 V output)	
AD	2.0mV	0.5mV	47 kΩ
TUNER/CD/ LINE/TAPE PLAY	126mV	31.5mV	20 kΩ
CD BALANCED	126mV	31.5mV	40 kΩ (20 kΩ/20 kΩ)

**OUTPUT LEVEL AND IMPEDANCE**

OUTPUT (BALANCED): 2.0 V, 50 Ω (25 Ω/25 Ω)/XLR type connector  
OUTPUT (UNBALANCED): 2.0 V, 1 Ω/Phono jack  
TAPE REC: 126 mV, 200 Ω/AD

**IMPEDANCE APPLICABLE TO HEADPHONE TERMINAL:**

4 to 100 Ω

**A-WEIGHTED SIGNAL-TO-NOISE RATIO**

Input terminal	Rated input		EIA S/N
	Input shorted, A-weighted		
AD	85 dB		85 dB
TUNER/CD/ LINE/TAPE PLAY	100 dB		92 dB
CD BALANCED	100 dB		92 dB

**MAXIMUM OUTPUT LEVEL (at 0.005% distortion, 20 to 20,000 Hz)**

OUTPUT (BALANCED): 10.0 V  
OUTPUT (UNBALANCED): 10.0 V  
TAPE REC: 19.0 V (AD)

**MAXIMUM INPUT LEVEL (at 0.005% distortion, 1 kHz)**

AD: 300 mV  
CD (BALANCED): 10.0 V

**MINIMUM LOAD IMPEDANCE**

OUTPUT (BALANCED): 600 Ω (300 Ω/300 Ω)  
OUTPUT (UNBALANCED): 1 kΩ  
TAPE REC: 10 kΩ

**VOLTAGE AMPLIFICATION IN DECIBELS**

TUNER, CD, LINE, TAPE PLAY → OUTPUT: 24 dB  
TUNER, CD, LINE, TAPE PLAY → TAPE REC OUTPUT: 0 dB  
AD → OUTPUT: 60 dB  
AD → TAPE REC OUTPUT: 36 dB

**LOUDNESS COMPENSATOR (volume attenuation at -30 dB)**

1: +3 dB (100 Hz)  
2: +8 dB (100 Hz), +6 dB (20 kHz)

**SUBSONIC FILTER**

10 Hz, -18 dB/oct.

**ATTENUATOR**

-20 dB, -30 dB, -∞

**SEMICONDUCTOR COMPLEMENT**

108 Tr's, 15 FETs, 27 ICs, 106 Di's

**POWER REQUIREMENT**

Voltage Selection by rewiring for 100, 117, 220, and 240 V, 50/60 Hz operation.  
Power Consumption: 40 W

**DIMENSIONS**

470 mm (18 1/2 inches) width  
145 mm (5 23/32 inches) max. height  
373 mm (14 11/16 inches) depth

**WEIGHT**

15.6 kg (34.4 lb) net, 20.6 kg (45.4 lb) in shipping carton

(The performance guaranty conforms to the EIA measuring method RS-490. "AD" stands for analog disc (LP).)



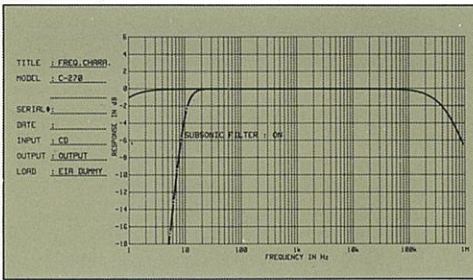

C-270 FREQUENCY CHARACTERISTICS  
INPUT: LINE  
OUTPUT: OUTPUT

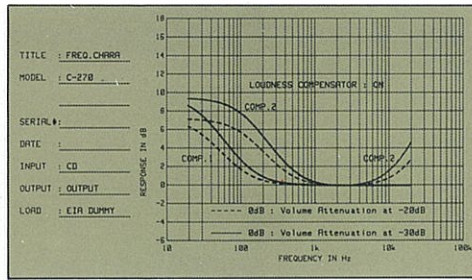

C-270 LOUDNESS COMPENSATOR  
CHARACTERISTICS  
INPUT: LINE  
OUTPUT: OUTPUT

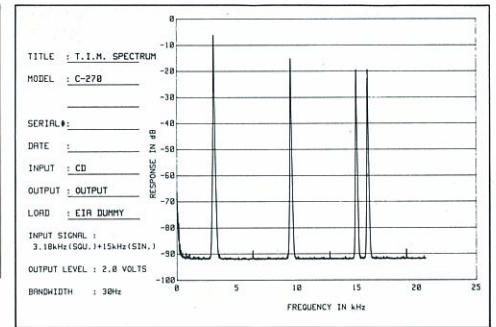

The above data shows the spectrum characteristics of transient intermodulation for the C-270 when two mixed signals, a 3.18 kHz square wave and a 15 kHz sine wave, are used. Since harmonics of square waves appear almost infinitely at odd number multiples, for example in this case at 9.54 kHz (3rd harmonic), 15.9 kHz (5th harmonic), they can create, together with the 15 kHz input sine wave, intermodulated spectrums at frequencies where input signals are absent. For example, if the third harmonic of the 3.18 kHz square wave (9.54 kHz) and the 15 kHz input signal intermodulate, a spectrum can appear at the difference of their frequencies or 5.46 kHz (15 - 9.54 = 5.46 kHz). However, the above data shows no spectrum above -93 dB at that frequency which confirms that TIM distortion is less than 0.0022%.

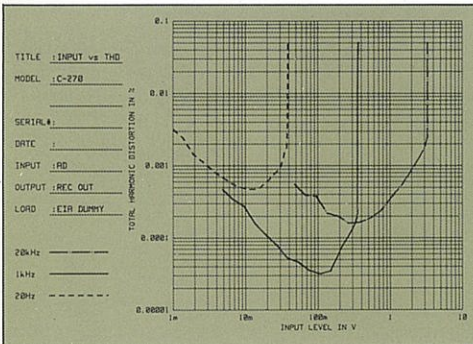

C-270 INPUT VOLTAGE vs. TOTAL  
HARMONIC DISTORTION  
INPUT: AD INPUT  
OUTPUT: RECORDING OUTPUT

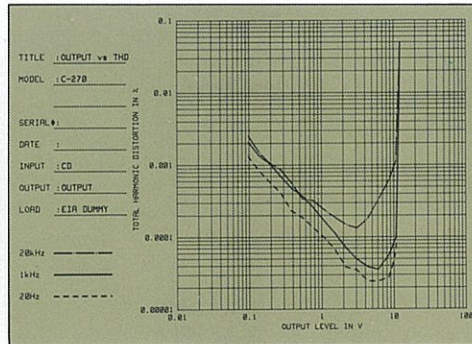

C-270 OUTPUT VOLTAGE vs. TOTAL  
HARMONIC DISTORTION  
INPUT: LINE  
OUTPUT: OUTPUT



### When using an MC (moving coil) cartridge

The C-270 has no built-in head amplifier for MC cartridges, therefore, a head amplifier or step-up transformer must be connected. The Accuphase C-17 head amplifier is available for this purpose. This high-quality amplifier provided with independent left and right channel power transformers. With this head amplifier, the full characteristics of an MC cartridge can be faithfully reproduced.

To accommodate the wide range of output voltages and input impedances of MC cartridges, gain can be set to 26dB or 32dB by selector switches. Additionally, the input impedance can be varied to 10, 30, or 100 ohms by selector switches.