

Accuphase

COMPACT DISC PLAYER

DP-80L

DIGITAL PROCESSOR

DC-81L



COMPACT  
disc  
DIGITAL AUDIO

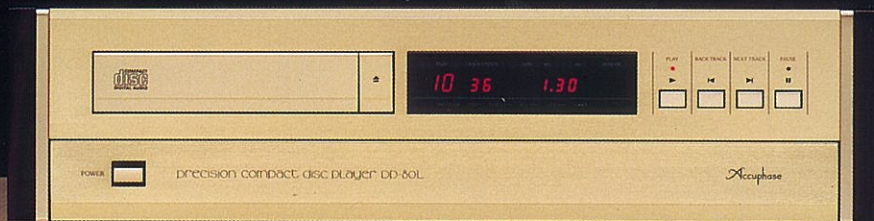

**A major advantage of digital audio is the possibility to fully recreate in the home the vibrant quality of the original musical performance—whether recorded at the studio or in the concert hall.**

**The Accuphase separate type CD player DP-80L/DC-81L is the ultimate instrument to turn this**

**ideal into reality. Leaving the area of merely adequate performance far behind, this ultimate Compact Disc reproduction system pushes back the theoretical limits of music reproduction. It is a work of supreme quality in the true Accuphase spirit.**

## CD PLAYER DEVELOPMENT PRINCIPLES

### Basic performance comes first

In the world of analog equipment, it is possible to give a component a certain sonic character which can enhance its aural impression. Digital components, on the other hand, have to transmit the entire musical information in encoded form. If even a small piece of this information is lacking, the result will sound distorted. When developing digital equipment, it is therefore important to first ensure that all the information is transmitted one hundred percent. Only after exploring the limits of physical performance can the designer attempt further measures to influence sound quality. Trying to cover up incomplete basic performance with cosmetic circuitry "enhancements" will not yield results which satisfy critical ears.

### Overall balance is vital

Various techniques to improve CD performance, such as oversampling digital filters, D/A converters with higher resolution, etc. have been developed. All of these certainly have the potential to enhance the sound of a CD player, but it does not suffice to make improvements merely in one or two limited areas. For such measures to be truly effective, they must be part of an integrated approach. Especially at the high general level of performance that has been achieved by modern audio equipment, further improvements can only be realized through a harmonious, carefully balanced reevaluation of the system as a whole.

### RF technology — an essential aspect

The signals handled by digital components have extremely wide bandwidth extending into the VHF range, i.e. the frequency of television broadcast signals. Many lesser components have problems when it comes to correctly dealing with this aspect. If spurious RF noise components are allowed to enter the audio circuits, the result is interference leading to a distinct degradation of sound quality. The disastrous effect RF emission can have on sound reproduction is clearly evident when an insufficiently shielded computer is placed close to a piece of audio equipment.

It is therefore of utmost importance to prevent digital signal interference and spurious noise emission. In order to effectively achieve this aim, a solid background not only in building audio equipment but also in RF technology is highly desirable. This will make it possible to create a truly state-of-the-art CD player.

Based on the above principles, Accuphase has thoroughly reevaluated every aspect of CD player performance. The result is a new pinnacle in the art of music reproduction.

### CD PLAYER DP-80L

Fig. 1 shows the block diagram of the CD Player DP-80L. This unit is designed to read the encoded information from the disc, convert it into an electrical signal using an EFM decoder and to restore the signal to its correct order with the error correction circuitry. The output signal supplied by the DP-80L is still in digital form. It must therefore be used together with a separate D/A converter unit such as the Digital Processor DC-81L. Three output terminals are provided: two optical outputs conforming to the EIAJ standard proposed by Accuphase and one coaxial output. By using the optical output and the supplied optical fiber cable, transmission losses are reduced to an absolute minimum, thus faithfully preserving even the most delicate musical nuances.

The drive assembly uses a newly developed mechanism which can accommodate 3-inch CDs. The drive is mounted on an aluminum diecast frame for absolutely stable operation. The extremely heavy and sturdy construction shuts out internal as well as external resonances to maintain optimum sonic purity. The enclosure provides a virtually hermetic shield, which together with the professional-quality AC line filter eliminates noise interference.

The front panel of the player is a model of functional simplicity, possessing only four buttons for Play, Pause, and Track Search. The controls for all other functions are located beneath a hinged sub panel door in the lower section. The highly pleasing, uncluttered esthetic appearance evokes the feel of a high-quality analog record player. But convenience is not sacrificed for good looks. A supplied long-range remote commander permits convenient operation of the unit from any location.

### DIGITAL PROCESSOR DC-81L

The block diagram of the digital processor unit DC-81L is shown in Fig. 2. A total of six inputs for digital signals are provided: three optical inputs conforming to the EIAJ standard and three inputs for 75-ohm coaxial cable. The unit also is equipped to handle three sampling frequencies, 48 kHz, 44.1 kHz, and 32 kHz. The DC-81L therefore can accommodate several CD players and can be used as a decoder also for a digital satellite broadcast tuner or DAT recorder.

It has become widely realized that the D/A converter has a decisive impact on sound quality. In the DC-81L, 20-bit conversion is used, which represents the current ultimate in D/A resolution. In true Accuphase tradition, the converter is made up of ultra-precise discrete circuit components for all bits. By carefully optimizing the vital circuits of the entire unit, zero-cross distortion is totally eliminated. This results in D/A conversion of previously unattainable precision.

The digital filter is a 20-bit type with 8-times oversampling. Its truly amazing performance is illustrated by specifications such as the attenuation of  $-110$  dB and ripple of  $\pm 0.00005$  dB. The fact that the filter and converter of the DC-81L are designed to handle a full 20 bits may seem like "overkill," as the Compact Disc format provides only for 16 bits. However, there are tangible advantages to this approach. The higher the bit rate of the filter and converter, the lower are conversion errors and noise in the output, even with a 16-bit input. In addition, the digital filter of the DC-81L also incorporates a noise shaper which reduces quantization noise to an absolute minimum.

For even higher performance, the digital filter and D/A converter block are electrically isolated from each other. A total of 42 high-speed optoisolators are used to transmit the signals between the two blocks. This total isolation between the digital and analog sections effectively prevents noise interference and sound quality degradation. Of course, the power supplies are also kept completely separate, using dedicated power transformers.

The analog filter is a GIC 3-pole Butterworth type active filter built with components specially selected on the basis of their sonic performance. The final output stage consists only of a direct-coupled discrete buffer amplifier with zero gain, for pure and straight signal transmission.

In addition to conventional unbalanced outputs, the DC-81L also provides a set of balanced XLR connectors. This ensures that the quality of the CD music signal is not impaired when sent to the amplifier. The digital output level control uses the full 20-bit potential for highly precise operation in 1-dB steps.

The use of highly sophisticated technology coupled with the typical Accuphase attention to detail has resulted in a CD player system that is second to none.





DP-80L. A professional-quality line filter is used to block any interference through the AC power line.

## 11 Simple and beautiful Accuphase design

The front panel presents an uncluttered appearance, as the controls are located behind a hinged sub panel door. The brushed gold aluminum

finish and the side panels made of exquisite persimmons wood further enhance the visual appeal of the unit. The DC-81L perfectly matches other Accuphase components and blends harmoniously with the listening room.

### About Digital Filters

The digital processor DC-81L employs a digital filter with 8-times oversampling. A digital filter is a circuit which carries out the filtering process while the signal is still in digital form. Unlike analog filters, the operation principles of digital filters are quite complex. The following is a brief outline of the concept of digital filtering.

#### The D/A converter output contains a large amount of high-frequency noise components which must be removed by a low-pass filter

Fig. 1 shows the circuit configuration of a conventional CD player from the D/A converter to the output. As the input signal to the converter is sampled at 44.1 kHz, the original waveform (a) becomes superimposed with the 44.1 kHz square wave signal, resulting in the staircase waveform (b). The output of the D/A converter contains the spectrum shown in Fig. 2 (a). In addition to the audio signal extending up to 20 kHz, there are high-frequency noise components at multiples of the sampling frequency (44.1 ± 20 kHz, 88.2 ± 20 kHz, 132.3 ± 20 kHz, etc.), reaching into the range of radio-frequency signals. Although these signals are outside the audible range, their removal is very important, as they can cause the following problems:

- (1) Intermodulation distortion in the nonlinear, ultra-high frequency range of audio circuits in the processor unit, preamplifier, or power amplifier. Such modulation generates distortion products which spread into the audible range and can degrade sound quality.
  - (2) Intrusion of noise components into other equipment such as tuners or tape recorders, causing the same problems.
  - (3) Output stage overload in wide-band amplifiers (such as all transistor amplifiers) due to constant high-frequency current.
  - (4) Overheating and damage of loudspeaker voice coils (especially tweeters) due to excessive high-frequency energy.
- For the above reasons, every CD player requires a filter to cut off high-frequency noise components above 20 kHz and to correctly restore the original signal.

#### Low-pass filters with sharp cutoff tend to degrade frequency response and phase characteristics

A low-pass filter, as its name implies, is designed to let signals below a certain frequency pass and cut off higher frequencies. A desirable characteristic for CD players is flat response (no attenuation) up to 20 kHz, and sharp attenuation above that, reaching at least -80 dB (preferably -90 dB) at 24 kHz. Low-pass filters are also used in other audio components such as preamplifiers, but the steepest slopes are usually -18 dB/oct.

Fig. 2 (b) shows the characteristics of a -18 dB/oct. filter. At 40 kHz, attenuation is -18 dB, at 80 kHz, it is -36 dB, and at 160 kHz, it reaches -54 dB. For a CD player, this of course will not do. In order to achieve the required characteristics shown in Fig. 2 (c), several filters can be employed in tandem (multi-pole filters), but it is a very difficult feat to ensure flat response to 20 kHz while introducing steep cutoff above this point.

In conventional CD players, 11-order filters were often employed, but such designs invariably introduce phase distortion and cause undulations (ripple) in the frequency response. Another disadvantage of such analog filters is the large number of circuit components required, which is an additional cause for nonlinear distortion.

If it were possible to use filters with a more gradual roll-off, these problems could be eliminated. The digital filter approach provides the ideal solution which does exactly that.

#### Digital filter increases sampling frequency to multiples of 44.1 kHz, permitting gentle analog filter characteristics

Fig. 2 (d) shows the frequency spectrum when the sampling frequency is multiplied by 8 times, to 352.8 kHz. As the components which have to be removed are now far outside the audible range, the low-pass filter can have a gentle cutoff slope, which is highly desirable in view of phase and ripple characteristics. The purpose of the digital filter is to perform the arithmetic operations required to multiply the sampling frequency. The configuration of a CD player with digital filter is shown in Fig. 3. The D/A converter is preceded by the digital filter and followed by the analog low-pass filter.

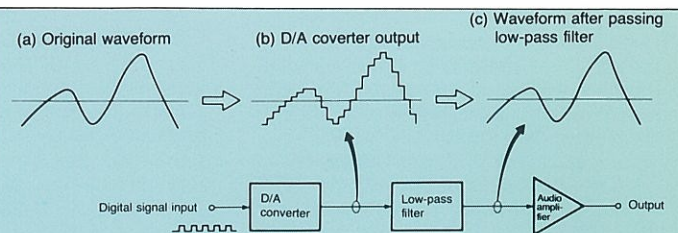
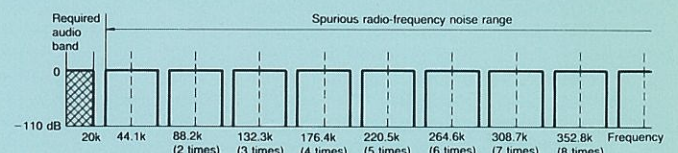
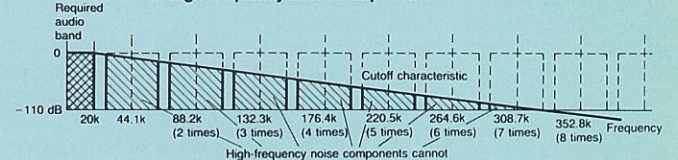

Fig. 1 Configuration of Typical CD Player



(a) D/A converter output contains a considerable amount of high-frequency noise components



(b) Conventional -18 dB/oct. filter cannot remove high-frequency noise satisfactorily

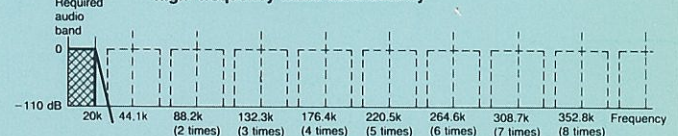

(c) Multi-pole analog filter developed for CD players

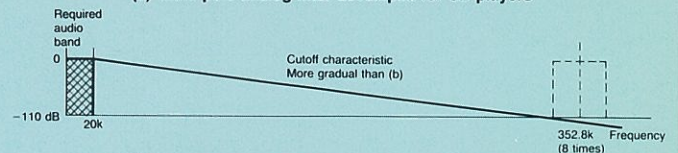

(d) 8-times oversampling increases sampling frequency to 352.8 kHz and permits use of gentle filter slope as in (b)

Fig. 2 D/A Converter Output Spectrum, Low-pass Filter Characteristics and Oversampling

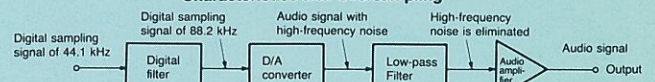

Fig. 3 Operational Concept of Digital Oversampling Filter

# Peerless optical fiber transmission

## Highly rigid massive construction Diecast mechanism frame



# DP-80L

## COMPACT DISC PLAYER

1

**Two wide-band optical outputs and a 75-ohm coaxial connector provide maximum versatility. Supplied optical fiber ensures ideal signal transmission characteristics**

The DC-81L offers two optical output connectors which correspond to the EIAJ standard that is proposed by Accuphase and is known as the Digital Interface standard. In addition, a connector for 75-ohm coaxial cable is also provided. The transmission rate of the wide-band optical connection is a full 10 MBit/sec. When the supplied high-quality optical fiber cable is used, this ensures transmission purity of the highest order, without any degradation of signal quality. As the player and processor units are electrically isolated from each other, any noise interference is effectively prevented. A professional-quality line filter blocks possible interference through the AC power line.

2

**Master clock principle for all timing signals prevents occurrence of beats**

The reference signal for various control functions within a CD player is created by a crystal clock oscillator. In conventional players, two oscillators are used for the digital signal processing circuitry and for the microprocessor. This approach has a distinct disadvantage: Even a slight frequency difference between the two clock signals can lead to beats, which in turn impair sound quality. As can be seen from Fig. 1, the DP-80L uses a single master clock to control the entire operation of the player. This leaves no room for sound quality degradation.

3

**Linear motor driven laser pickup with 8-bit microprocessor control accesses any track in less than 1 second**

A great advantage of the CD format is easy track selection at the simple touch of a button. The DP-80L minimizes track access time with highly sophisticated technology. A linear motor mechanism moves the laser pickup under exclusive control of a specially developed 8-bit microprocessor. Thanks to this approach, locating any track never takes longer than one second. Disc tray action also is exceptionally smooth and swift, with excellent feel.

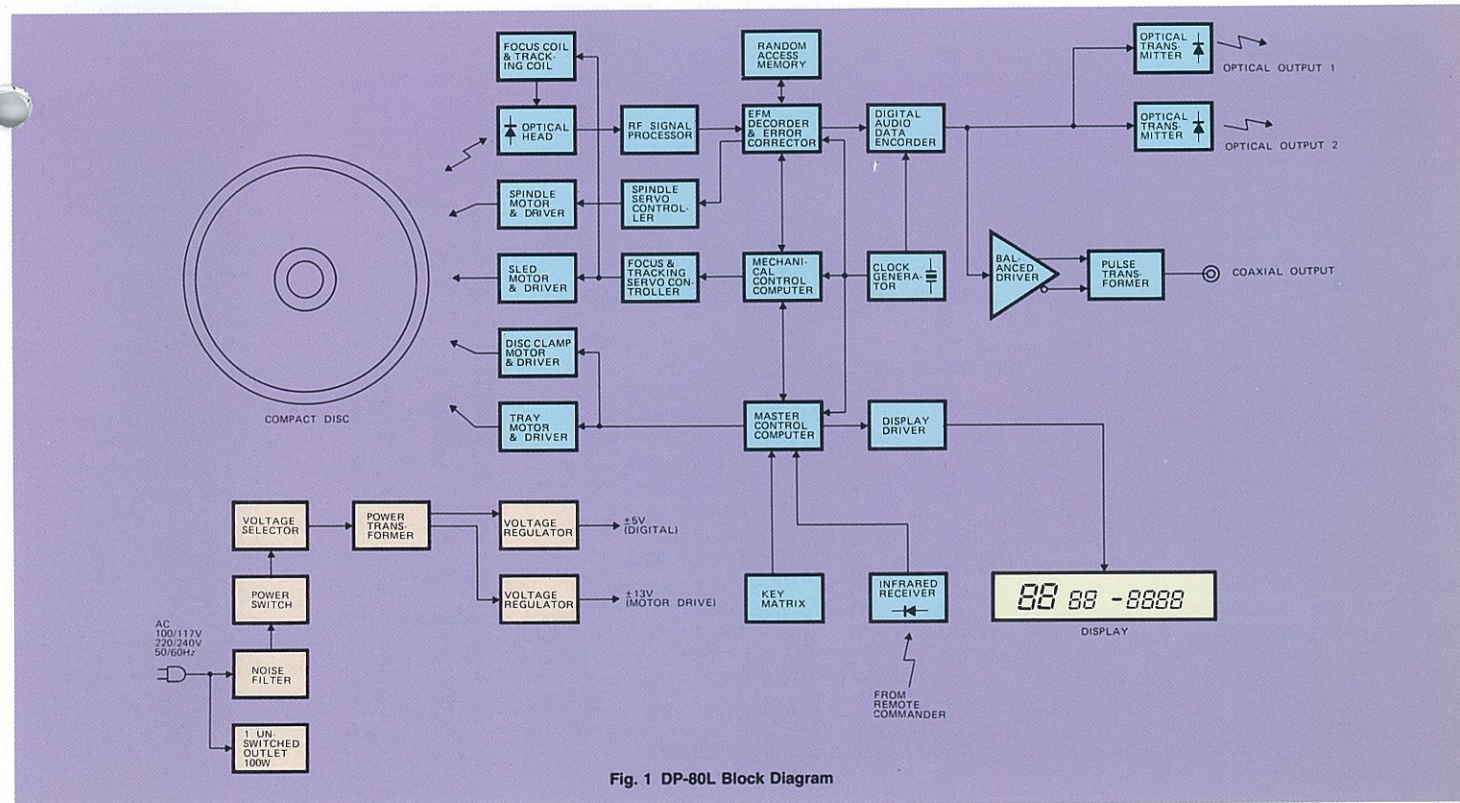
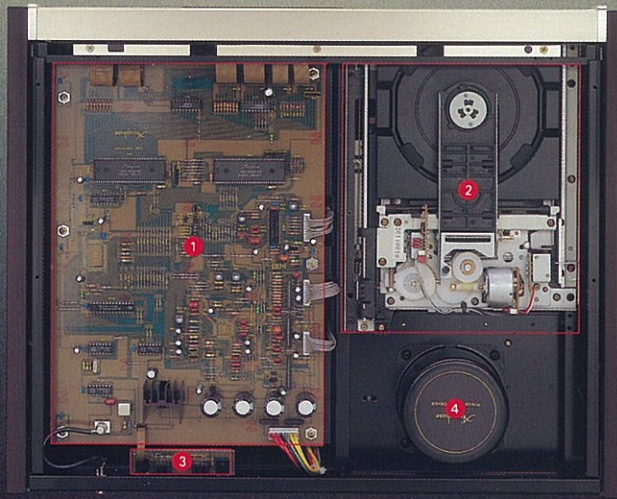

Fig. 1 DP-80L Block Diagram



1 Servo circuits, signal processing circuits, mechanism control circuits, master clock generator, etc. ICs are also mounted on the other side.

2 Cd mechanism assembly  
 • The entire mechanism is mounted on an aluminum diecast frame to prevent resonances, and floating suspension from chassis suppresses vibrations.

3 Transmitter for optical fiber transmission  
 4 Power transformer

#### 4 Non-resonant mechanism construction with aluminum diecast frame and floating suspension effectively suppresses all vibrations.

The Compact Disc rotates at the considerable speed of 200 to 500 revolutions per minute. Therefore it is necessary to adopt measures against internal resonances. Otherwise circuit components may vibrate, which has a negative effect on the reproduced sound. In the DP-80L, the entire mechanism is mounted on a sturdy aluminum diecast frame, and this frame is in turn isolated from the chassis by a floating construction. This not only prevents internal resonances, it also ensures that no vibrations from outside the unit can be transmitted to the disc tray.

#### 5 Massive, heavy chassis subdues resonances

The weight of the DP-80L is a full 15 kg, which is extremely heavy for a CD player unit. A large part of this weight is due to the extensive measures against resonances and vibrations. The rotation section is supported by a strong metal frame, and the strong chassis itself also is designed to withstand all sorts of vibrations. Operation is highly stable and air-borne sound pressure from the speakers or characteristics of the installation location cannot influence the sound.

#### 6 Operational 'feel' of an analog record player

Like all Accuphase components, the DP-80L presents an external appearance of striking simplicity. The uncluttered front panel is a welcome change from ordinary CD players. Only four control buttons are visible: PLAY, TRACK SEARCH (BACK/NEXT), and PAUSE. Operating the DP-80L evokes the feel of a high-class analog record player. But other functions are not absent. The controls for a sensible array of functions are located behind a hinged sub panel door in the lower section of the front panel. The supplied remote commander RC-2 also lets the user control all functions of the player from the listening position.

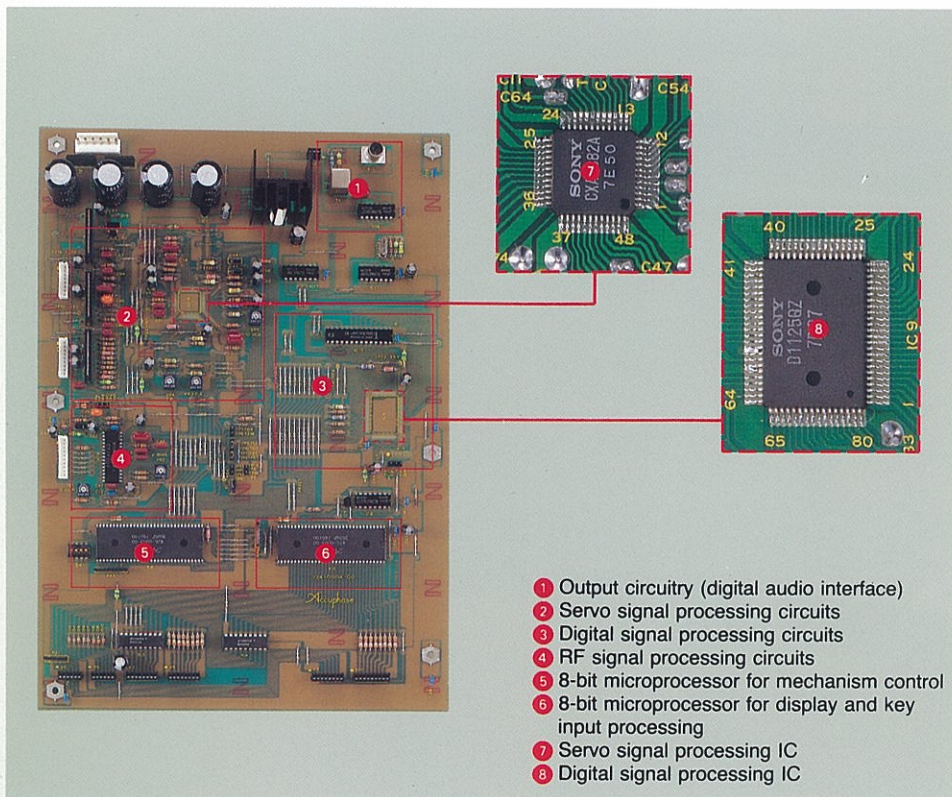

- 1 Output circuitry (digital audio interface)
- 2 Servo signal processing circuits
- 3 Digital signal processing circuits
- 4 RF signal processing circuits
- 5 8-bit microprocessor for mechanism control
- 6 8-bit microprocessor for display and key input processing
- 7 Servo signal processing IC
- 8 Digital signal processing IC



#### 7 Simple and beautiful Accuphase design

The panel is finished in brushed gold aluminum, and the visual appeal of the unit is further enhanced by the side panels made of exquisite persimmons wood. The DP-80L perfectly matches other Accuphase components and blends harmoniously with the listening room.



# Ultra precise 20-bit discrete D/A converter

## 20-bit 8-times oversampling Compatible with 3 sampling frequencies



**DC-81L**  
DIGITAL PROCESSOR

### 1 20-bit discrete D/A converter approaches the theoretical limits of performance

The D/A converter is an essential component in the Compact Disc reproduction chain, as it transforms the digital information back into an analog audio signal. Similar to the circuit elements which determine linearity in an amplifier, the performance of the D/A converter has an enormous bearing on the sound quality of a CD player.

The DC-81L represents a breakthrough in D/A converter technology. For the first time in a consumer audio product, it incorporates a 20-bit converter built with discrete circuit components. But the innovation does not stop there. Instead of merely adding bits above or below the regular 16 bits of the CD format, the precision of each bit itself is improved by a factor of  $1/2^{20} = 9.54 \times 10^{-7}$ . Expressed in simple terms, digital-to-analog conversion with the DC-81L is as much as 16 times more precise than with a conventional 16-bit converter. Distortion components at 1 kHz amount to a mere 0.0005%, which represents the theoretical limit of CD player performance. Quantization noise, another obstacle to truly outstanding CD reproduction, is also reduced to absolutely negligible levels.

The converter of the DC-81L uses the current summing principle, which provides superior linearity. The entire 20-bit converter circuitry is built using carefully selected discrete components, a feat that is not matched by any other manufacturer. The right section of Fig. 3 shows the operation principle of the converter, which consists of an array of current switching elements and ultra-high precision resistors. Each unit is individually adjusted for optimum performance, to virtually eliminate distortion at low signal levels (commonly called zero-cross distortion).

### 2 Separate 20-bit 8-times oversampling digital filters for each channel

The digital filter multiplies the sampling frequency by a factor of eight, thereby moving the spurious noise components far outside the audible range. The subsequent analog filter consequently can have a gentle cutoff slope, which is highly desirable to prevent sound quality degradation due to phase errors. Simply increasing

the conversion rate is not enough, however. Careful matching to the analog stage and correct filter design are also of great importance.

The digital filter of the DC-81L uses highly sophisticated processing algorithms to achieve a truly impressive attenuation of  $-110$  dB between 24.1 and 328.7 kHz. Ripple components in the passband, which can also audibly degrade the signal, have been reduced to an astonishing  $\pm 0.00005\%$ . This represents the absolute state-of-the-art in digital filter performance.

### 3 GIC 3-pole Butterworth type active filter with hand-selected components

As the digital filter uses 8-times oversampling, the conversion rate of the D/A converter becomes 352.8 kHz. The output signal of the converter therefore contains unwanted high-frequency components only at  $352.8 - 20 = 332.8$  kHz, as well as at higher frequencies (multiples of 16, 24, etc.). To reliably remove these, a third-order analog low-pass filter with gentle roll-off characteristics (18 dB/oct.) is perfectly sufficient. This is an important advantage, as such a

filter introduces no unwanted phase errors effects in the audible range. The GIC (Generalized Impedance Converter) 3-pole Butterworth type active filter in the DC-81L is built with supreme-quality selected components, to assure utterly pure sound quality.

### 4 21 optoisolators in each channel ensure perfect electrical isolation of digital filter and D/A converter

High-frequency noise from the digital section can have a disastrous effect on sound quality if permitted to enter the audio circuits. The DC-81L reliably prevents this by electrically separating the D/A converter from the preceding sections and transmitting the signal by optical means. The left section of Fig. 3 shows the operation principle. The data for each bit pass through a dedicated high-speed optoisolator (transmission rate 7 MBit/second). This ensures electrical isolation and blocks any noise components. The output signal of the optoisolators passes through the mother PCB outside the shielded frame to the converter in the magnetically and electrically shielded analog circuit block.

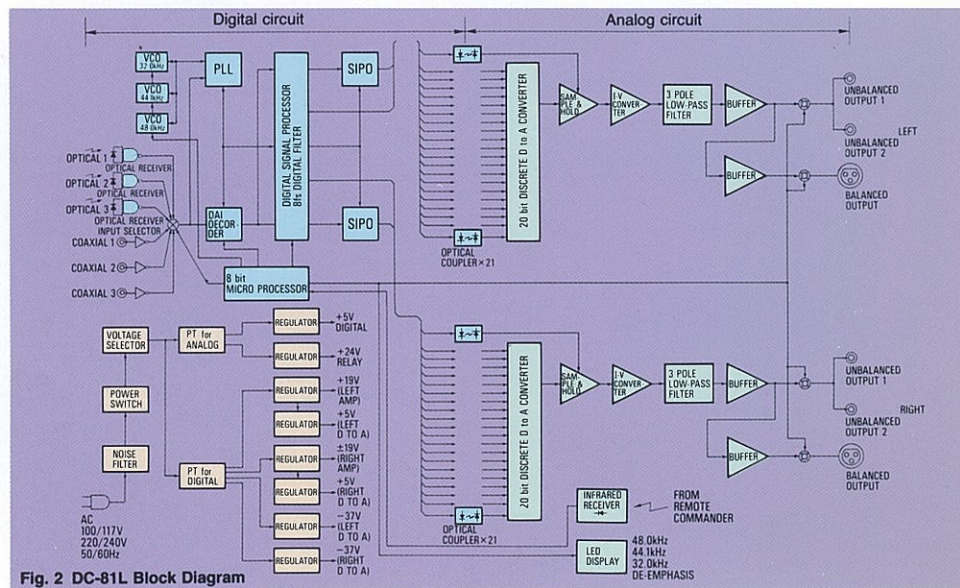
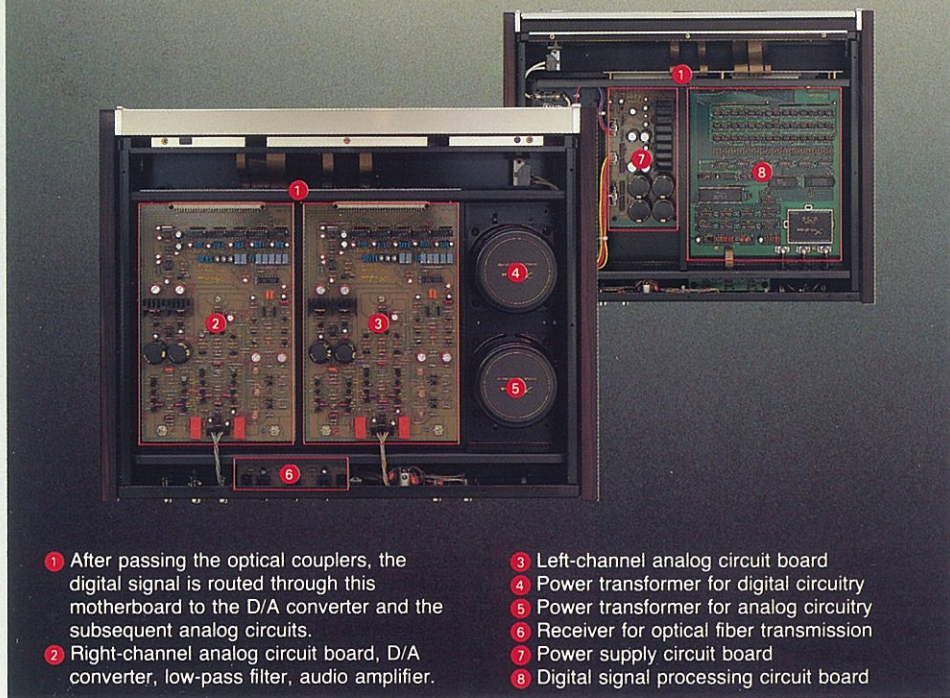

Fig. 2 DC-81L Block Diagram



- 1 After passing the optical couplers, the digital signal is routed through this motherboard to the D/A converter and the subsequent analog circuits.
- 2 Right-channel analog circuit board, D/A converter, low-pass filter, audio amplifier.

- 3 Left-channel analog circuit board
- 4 Power transformer for digital circuitry
- 5 Power transformer for analog circuitry
- 6 Receiver for optical fiber transmission
- 7 Power supply circuit board
- 8 Digital signal processing circuit board

## 5 Three sampling frequencies and six inputs (3 optical, 3 coaxial) provide unsurpassed versatility

DAT recorders will appear to have a digital output in the near future. To accommodate such needs, the DC-81L automatically detects the sampling frequency of the input signal (48, 44.1, or 32 kHz) and adjusts itself accordingly. Additional flexibility is provided by the wide choice of inputs, which includes three optical terminals and three connectors for coaxial cable.

## 6 Noise shaper further reduces quantization noise

The noise shaper is an ingenious circuit which uses feedback of tolerance errors in the digital filter to decrease noise in the audible range. Together with the 20-bit conversion principle, this results in utter freedom from noise. Music reproduction becomes almost uncannily real, as even the most delicate musical nuances are faithfully preserved.

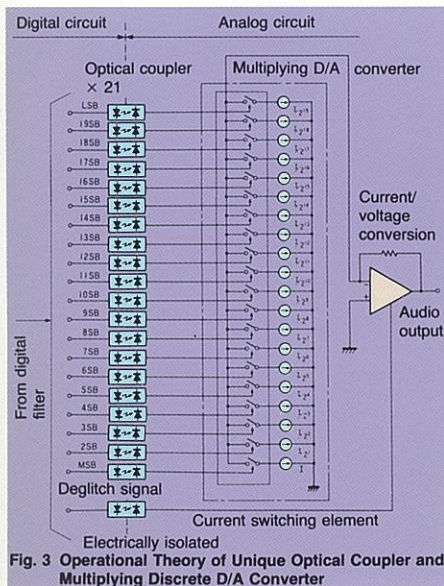

## 7 Deemphasis with top-notch performance approaching physical limits: precision of 0.001 dB and phase aberrations under 1.5 degrees

Some CDs are recorded with preemphasis, that is the high frequencies are boosted during recording and must be attenuated by the same amount in playback. This technique, which improves the overall signal-to-noise ratio of the reproduction chain, is mostly used in digital tape recording, but it can still be found in a number of CDs as well. Such CDs also include a special signal that is detected by the player, causing it to automatically engage the deemphasis circuit. An RC (resistor-capacitor) network is commonly used to provide the required attenuation. But the DC-81L takes a different approach. It provides deemphasis while the signal is still in digital form, thereby achieving outstanding precision. Deemphasis aberrations are a mere  $\pm 0.001$  dB and phase errors less than 1.5 degrees. This lets any CD sound its very best.

## 8 Direct-coupled output stage with 0 dB gain buffer

The final audio stage of a CD player also has a considerable influence on sound quality.

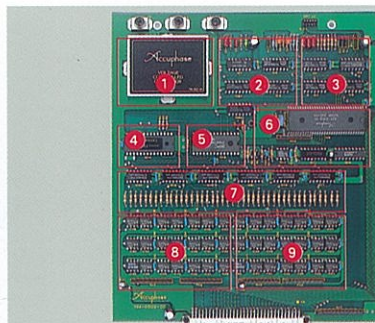

- 1 3-frequency Vco (voltage controlled oscillator)
- 2 PLL circuit
- 3 Input selector control circuit
- 4 Digital audio data demodulator IC
- 5 Digital signal processor
- 6 8-bit microprocessors and peripheral circuitry
- 7 Serial-to-parallel converters
- 8 Right channel: 20-bit data and deglitch

Accuphase engineers have achieved impressive results in this area as well. By designing the D/A converter for an output level which requires no further amplification, a no-gain buffer amplifier of desirably simple construction can be used. The circuit uses discrete components in a push-pull DC servo configuration, for ultimate S/N ratio and stable low-distortion performance.

## 9 Digital level control adjustable by remote commander. Two unbalanced and one balanced outputs.

A conventional CD player, while usually permitting track selection with the remote control, still makes you reach for the amplifier's volume knob if you want to change the listening volume. Not so in the case of Accuphase.

The DC-81L has ultra-precise digital level controls which fully bring out the advantages of the 20-bit principle. Sound quality remains totally natural and pure, even at very low listening levels. The output level can be conveniently adjusted with the remote commander supplied with the DP-80L.

For the output, two pairs of RCA type phono jacks are provided to meet conventional requirements, and a set of balanced XLR connectors permits balanced connections. Accuphase is promoting balanced cable connections between the amplifier components of the reproduction chain, for noise-free, high-quality signal transmission.

## 10 Thoroughly interference-proof design

By using highly sophisticated techniques such as optical fiber connections between the player and processor unit and optoisolators to separate the digital and analog circuit sections, high-frequency noise transmitted via cables can be reliably blocked. But it is equally important to deal with the problem of air-borne spurious radiation or noise transmitted via the AC power line. The DP-80L and DC-81L provide perfect solutions in this regard also, by employing separate thorough shielding for the digital and analog blocks and by using totally separate power transformers.

In the analog section, separate circuit boards and separate transformer windings are used for the left and right channels, to prevent inter-channel interference.

Spurious radiation from the digital circuitry must also be prevented from reaching other audio components. Accuphase has gained extensive experience in this area through the development of its high-quality tuners. This experience is in evidence in the perfect internal shielding of the

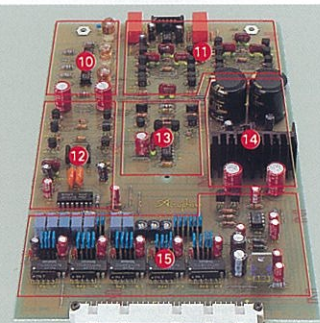

- 9 signal optical coupler
- 9 Left channel: 20-bit data and deglitch signal optical coupler
- 10 GIC 3-pole Butterworth filter
- 11 Balanced output amplifier
- 12 Current-to-voltage converter circuit
- 13 Buffer amplifier
- 14 Power supply regulator circuit
- 15 Ultra high precision 20-bit discrete D/A converter

## GUARANTY SPECIFICATIONS

### Performance Guaranty

All Accuphase product specifications are guaranteed as stated.  
This system complies with the EIAJ CP-307.

### CD Player DP-80L

- **Type:** Digital player for compact disc system
- **Format:**  
Standard CD format  
Error correction principle: CIRC  
Number of channels: 2  
Revolution speed: 500 – 200 rpm  
(constant linear velocity)  
Scan velocity: 1.2 – 1.4 m/s, constant
- **Data read:**  
Non-contact optical pickup (semiconductor laser)
- **Laser:**  
Semiconductor laser: GaAlAs (double heterodyne diode)
- **Semiconductor complement:**  
6 transistors, 21 ICs, 20 diodes
- **Power requirements:**  
Voltage selection by for 100V, 117V, 220V and 240V, 50/60 Hz  
Power consumption: 15W
- **Dimensions:**  
475 mm (18-23/32 inches) width, 135 mm (5-5/16 inches) (including legs) height, 373 mm (14-11/16 inches) depth

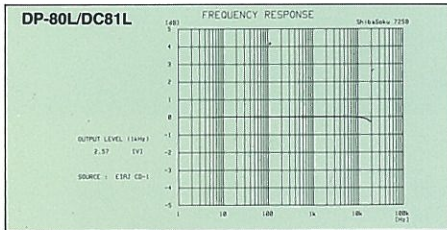

• Frequency Characteristic

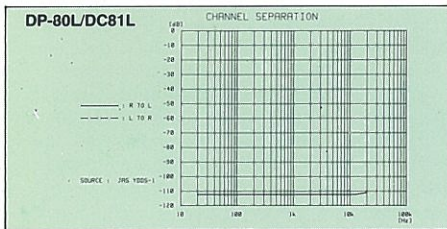

• Channel Separation Characteristic

- **Weight:**  
15 kg (33.1 lb) net, 20 kg (44.2 lb) in shipping carton
- **Supplied Remote Commander RC-2**  
Remote control principle: infrared pulse  
Power supply: 3V DC with batteries IEC designation R6 (size AA)  
Dimensions:  
64 mm (2-9/16 inches) width, 176 mm (6-15/16 inches) depth, 18 mm (6/8 inches) height  
Weight: 180g (6.4 oz) (including batteries)

### Digital Processor DC-81L

- **Type:** Digital processor unit
- **Format:** Standard EIA format
- **Number of quantization:** 16 bit linear
- **Sampling frequencies:**  
32.0 kHz, 44.1 kHz, 48.0 kHz
- **Frequency response:** 4.0 – 20,000 Hz  $\pm 0.3$  dB
- **D/A converter:** Discrete 20-bit type
- **Digital filter:**  
20-bit 8-times oversampling filter  
Integrated noise shaper  
Digital deemphasis  
Tolerance  $\pm 0.001$  dB
- **Total harmonic distortion + noise:**  
0.0016% (1,000 Hz)  
0.002% (20 – 20,000 Hz)

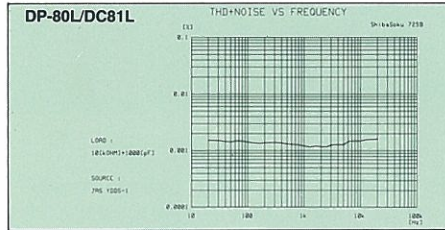

• THD + Noise vs. Frequency Characteristic

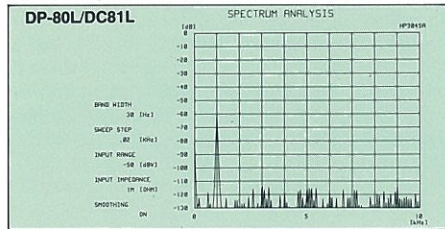

• Spectrum Analysis of Reproducing Signal at 1 kHz: -60 dB

- **Signal-to-noise ratio:** 120 dB
- **Dynamic range:** 98 dB
- **Channel separation:** 112 dB
- **Rated output level and impedance**  
BALANCED: 2.5V/50 ohms (25/25 ohms), balanced XLR type connector  
UNBALANCED: 2.5V/50 ohms, RCA type phono jack
- **Output level control:**  
0 to -40 dB in 1-dB steps (digital control)
- **Digital signal output format and level (EIA)**  
Format: Digital audio interface  
OPTICAL: Input -15 to -27 dBm  
COAXIAL: 0.5V<sub>p-p</sub>, 75 ohms
- **Semiconductor complement:**  
89 transistors, 5 FET, 98 ICs, 54 diodes
- **Power requirements:**  
Voltage selection by for 100V, 117V, 220V and 240V, 50/60 Hz  
Power consumption: 35W
- **Dimensions:**  
475 mm (18-23/32 inches) width, 135 mm (5-5/16 inches) (including legs) height, 373 mm (14-11/16 inches) depth
- **Weight:**  
15.9 kg (35.1 lb) net, 20.9 kg (46.3 lb) in shipping carton

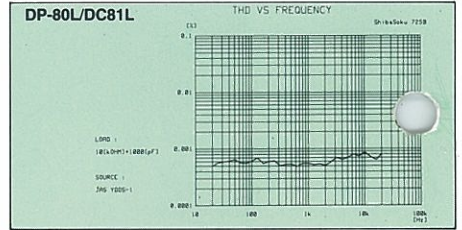

• THD vs. Frequency Characteristic

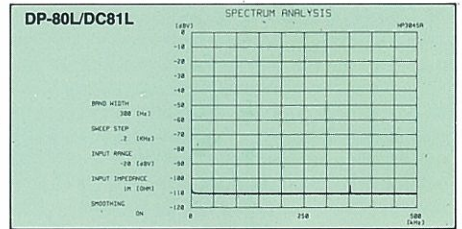

• Spectrum Analysis of Non-signal Reproduced Noise vs. Frequency Characteristic (352.8 kHz sampling frequency is attenuated to about 105 dBV.)

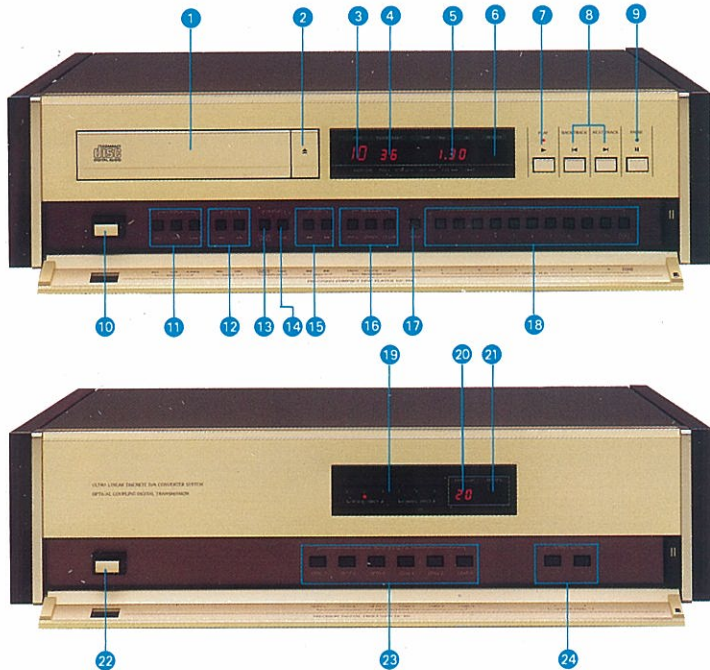

- 1 Disc tray
- 2 Disc tray OPEN/CLOSE key
- 3 Play indicator
- 4 Track/INDEX indicator
- 5 TIME display
- 6 REMOTE sensor
- 7 PLAY key
- 8 TRACK search keys
- 9 PAUSE key
- 10 Power switch
- 11 REPEAT keys
- 12 INDEX search keys
- 13 TRACK/INDEX display key
- 14 Time display key
- 15 FAST key
- 16 PROGRAM keys
- 17 STOP (reset) key
- 18 DIRECT PLAY keys
- 19 INPUT/EMPHASIS/SAMPLING FREQUENCY indicators
- 20 OUTPUT LEVEL indicator
- 21 REMOTE sensor
- 22 Power switch
- 23 INPUT SELECTOR
- 24 OUTPUT LEVEL selector