

# Accuphase

INTEGRATED STEREO AMPLIFIER

## E-211

- Parallel push-pull output stage delivers quality power: 90 watts per channel into 8 ohms
- Current feedback circuit topology prevents phase shifts
- Logic-controlled relays for optimum signal routing
- High-quality Tone controls
- Balanced inputs
- Option board allows high-quality analog disc reproduction
- Two sets of speaker outputs
- Supplied remote commander



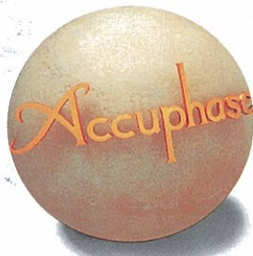

**Sheer musical exhilaration – A new integrated amplifier with current feedback topology and a full complement of valuable features. The drive stage uses power MOS-FETs, and the parallel push-pull output stage employs high-current power transistors delivering 90 watts/channel of quality power into 8 ohms. Option board allows analog disc playback with impeccable quality.**

The E-211 is a further refined successor model to the highly acclaimed E-210. It adds power meters, tone controls and other features while retaining the simple design and impeccable sound that is made possible by Accuphase technology developed for our celebrated separate components. While surprisingly affordable, the E-211 delivers performance that far surpasses the realm of conventional products in this class.

In an integrated amplifier, overall gain is very high. Consequently, even minute interference or noise at the input side can severely degrade sound quality. To prevent this, the E-211 keeps the line amplifier and power amplifier sections entirely separate, both regarding mechanical construction and electrical circuitry. This keeps the signal path simple, while totally eliminating the possibility of mutual interference between the low-level signal switching sections and the power amplification circuitry. The result is a clear improvement in sonic purity. Another significant advantage is the current feedback topology developed by Accuphase. It virtually eliminates phase shifts in the upper frequency range and assures uniform frequency response which does not change with gain. Total operation stability is combined with excellent frequency response. Thanks to this principle, phase compensation can be kept at a minimum, and high amounts of negative feedback with their associated disadvantages are no longer required.

The output stage employs a parallel push-pull configuration of multi-emitter type power transistors designed for high-current audio applications. The drive stage uses MOS-FET devices which have negative temperature characteristics. This means that there is no danger of thermal "runaway" as exists with bipolar transistors, assuring stable operation under all circumstances.

In the standard configuration, the E-211 provides five inputs including a balanced input. An additional line input can be added as an option. Another attractive option is the analog disc input board, which provides high-quality phono playback. This will be welcomed by audiophiles with a treasured collection of analog records.

Tone controls configured as summing active filter circuits provide flexibility without diluting the purity of the music signal. A loudness compensator allows precise adjustment and restores proper sonic balance at low listening levels.

**Parallel push-pull power unit delivers 115 watts/ch into 4 ohms, 105 watts/ch into 6 ohms, and 90 watts/ch into 8 ohms**

The transistors used in the output stage are quality devices designed for audio applica-

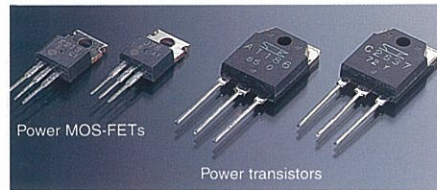

tions, with high collector dissipation, optimum high-frequency characteristics, and superior resistance to current breakdown. The power transistors are devices designed for high-power audio applications, with outstanding linearity and switching performance characteristics. By mounting these transistors to a large efficient heat sink and connecting them in parallel, the E-211 achieves ample power output capabilities, providing 115 watts into 4 ohms, 105 watts into 6 ohms, or 90 watts into 8 ohms per channel.

The driver stage uses MOS-FET devices with

negative temperature characteristics, which cancels out the thermal characteristics of the power transistors and guarantees perfectly stable operation.

**Current feedback circuit topology prevents phase shifts**

Conventional amplifiers employ voltage NFB, whereby the output voltage is used for the feedback loop. In the E-211, however, the sig-

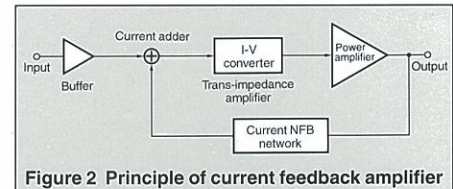

Figure 2 Principle of current feedback amplifier

nal current rather than the voltage is used for feedback. Figure 2 shows the operating principle of this circuit. At the sensing point of the feedback loop, the impedance is kept low and current detection is performed. An impedance-converting amplifier then converts the current into a voltage to be used as the feedback signal. Since the impedance at the current feedback point (current adder in Figure 2) is very low, there is almost no phase shift. Phase compensation can be kept to a minimum, resulting in excellent transient response and superb sonic transparency. Figure 3 shows frequency response for different gain settings of the current feedback amplifier. The graphs demonstrate that response remains uniform over a wide range.

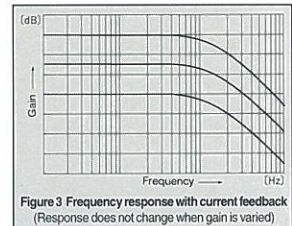

Figure 3 Frequency response with current feedback (Response does not change when gain is varied)

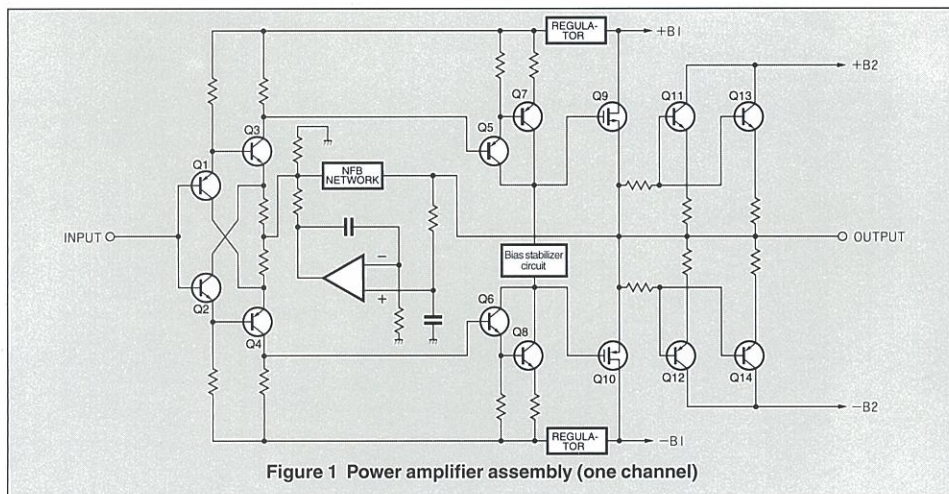
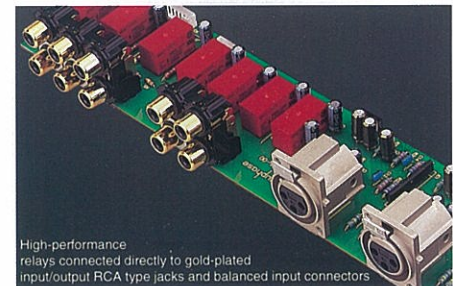

Figure 1 Power amplifier assembly (one channel)

**Highly reliable logic-controlled relays**

Long signal paths for functions such as input switching and tape monitoring tend to degrade high-frequency response and impair imaging.



High-performance relays connected directly to gold-plated input/output RCA type jacks and balanced input connectors

The hermetically sealed relays are high-quality types developed specifically for demanding communication applications. The contacts



- Supplied remote commander RC-23 Allows volume adjustment and input source switching

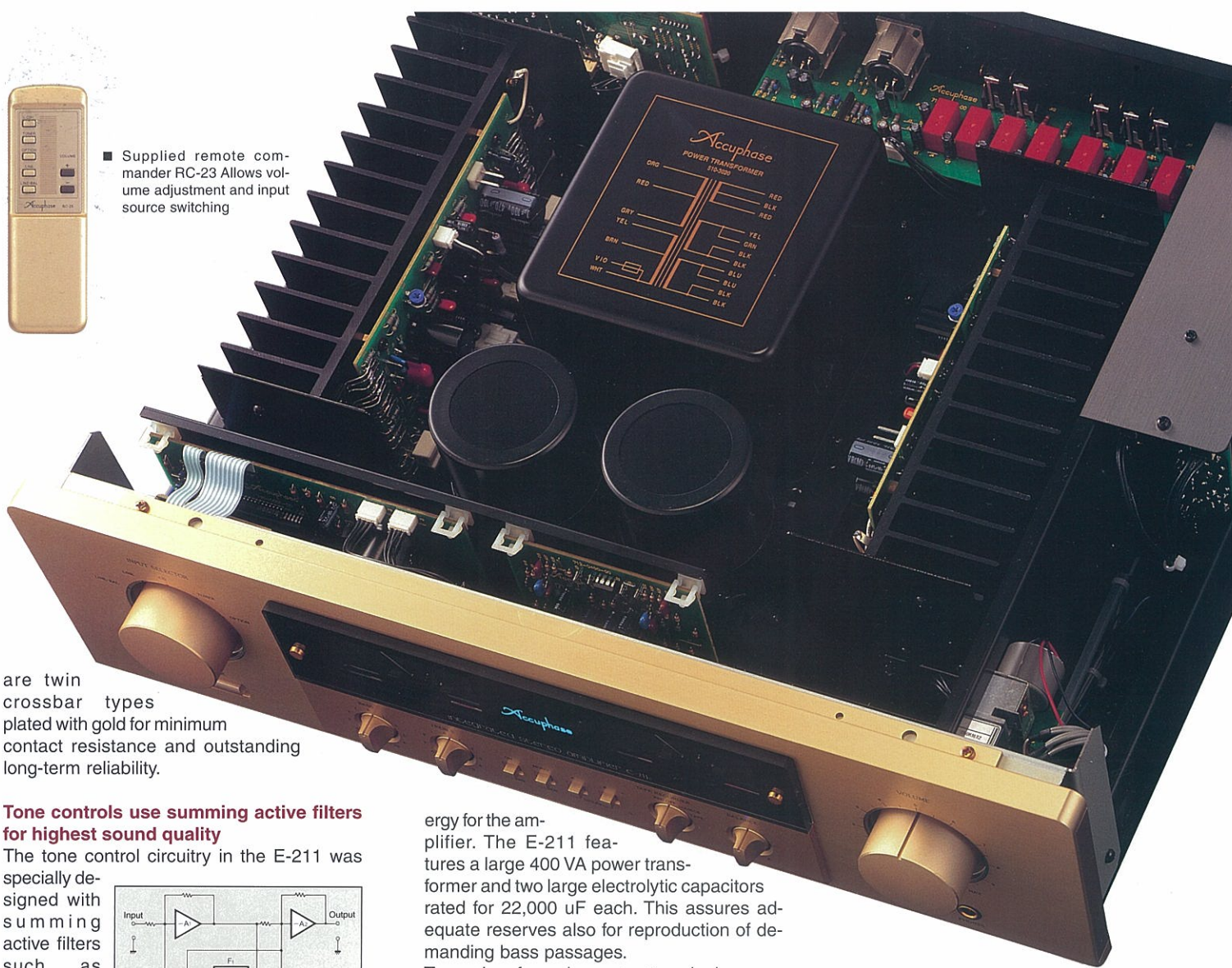

are twin crossbar types plated with gold for minimum contact resistance and outstanding long-term reliability.

**Tone controls use summing active filters for highest sound quality**

The tone control circuitry in the E-211 was specially designed with summing active filters such as found in high-quality graphic equalizers. Figure 4 illustrates the

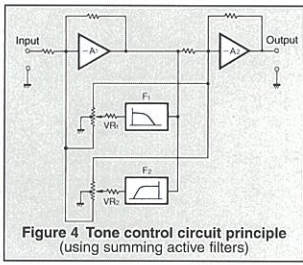

Figure 4 Tone control circuit principle (using summing active filters)

operation principle of this circuit. The flat signal is passed straight through, and only when an adjustment is required, the characteristics are created at F1 and F2 and added to the signal, thereby producing the desired change. This design provides efficient control without degrading signal purity.

**Strong power supply with large power transformer and high filtering capacity**

The power supply serves as the source of en-



Massive power transformer and large electrolytic capacitors

ergy for the amplifier. The E-211 features a large 400 VA power transformer and two large electrolytic capacitors rated for 22,000 uF each. This assures adequate reserves also for reproduction of demanding bass passages.

Two pairs of speaker output terminals The oversize speaker terminals accept even very heavy-gauge speaker cable. Two switch-selectable outputs are provided, allowing you to drive two pairs of loudspeakers. Bi-wiring is also possible.

**High-quality volume control. Remote commander allows source switching and volume adjustment**

The quality of the volume control has a considerable influence on the sound of an amplifier. The E-211 employs a high-grade device which can also be operated via the supplied

remote commander. Input source switching is also possible.

**Direct-reading peak power meters**

The large analog power meters use logarithmic compression to cover a wide dynamic range. The peak hold function lets the user easily monitor the output level of the rapidly fluctuating music signal.

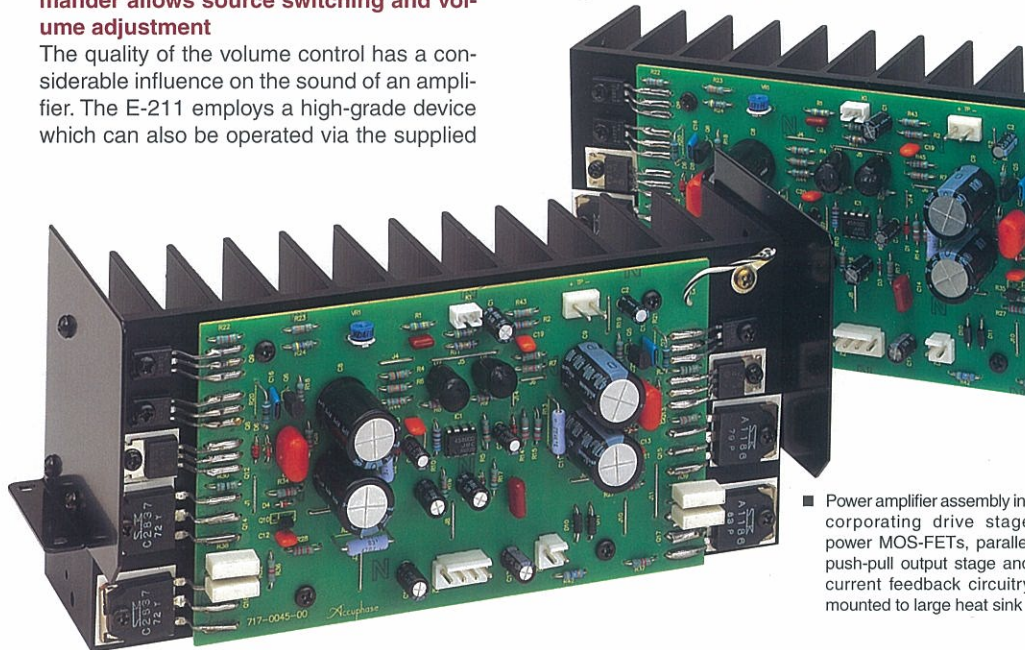

- Power amplifier assembly incorporating drive stage power MOS-FETs, parallel push-pull output stage and current feedback circuitry mounted to large heat sink

## Versatile input configuration including balanced connectors

The input selector of the E-211 controls five inputs (including the optional input) plus the tape recorder input. One input is designed for balanced connections. The balanced principle is impervious to externally induced noise, ensuring noise-free signal transmission with optimum sonic purity.

## Two pairs of speaker output terminals

The oversize speaker terminals accept even very heavy-gauge speaker cable. Two switch-selectable outputs are provided, allowing you to drive two pairs of loudspeakers. Bi-wiring is also possible.

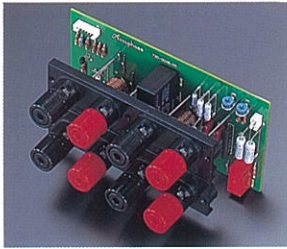

## Option Boards

The rear panel of the E-211 provides a slot in which an optional input board can be installed. Choose the board (AAB standard) that fits your desired application.

- The Line Input Board LINE-10 and the Analog Disc Input Board AD-10 can also be used.



### Line Input Board LINE-9

This option board provides an additional set of conventional line inputs which can be used to connect a CD player, tuner, or other component with analog output.

### Analog Disc Input Board AD-9

This board contains a high-performance, high-gain phono equalizer. The board can be used with any type of phono cartridge.

Internal DIP switches control MM/MC operation, MC input impedance, and subsonic filter on/off.

MM	Gain	: 36 dB
	Input impedance	: 47 kohms
MC	Gain	: 62 dB
	Input impedance	: 10/30/100 ohms (selectable)

- The boards use the AAB (Accuphase Analog Bus) interface.

## Front Panel

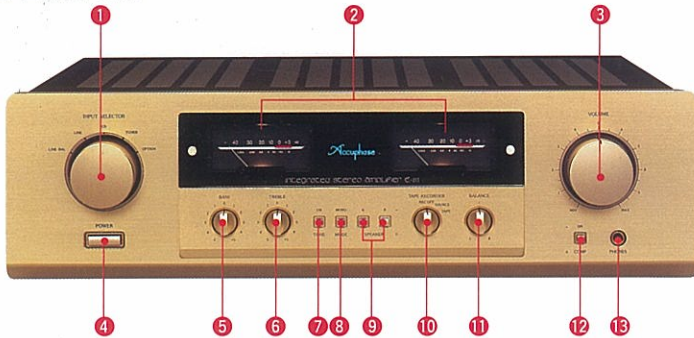

## Rear Panel

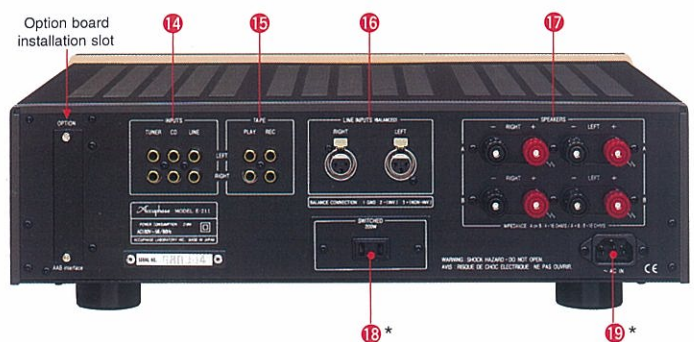

- Input selector  
LINE-BAL LINE CD TUNER OPTION
- Left and right channel output meters  
(dB/wattage scale, direct reading)
- Volume control
- Power switch
- Bass control
- Treble control
- Tone control on/off button
- Stereo/mono button
- Speaker selector buttons
- Recording output/tape monitor switch  
REC OFF SOURCE TAPE
- Balance control
- Loudness compensator
- Headphone jack
- Line input jacks
- Tape recorder record/play jacks
- Balanced line input connectors
- Left/right speaker output connectors A, B
- Switched AC outlet \*
- AC connector (for supplied power cord) \*

### Remarks

\* The shape of the AC inlet, plug of the supplied power cord, and AC outlet depends on the voltage rating and destination country.

\* This switched AC outlet may not be supplied depending on the safety standards or regulations applicable in the particular country to where the unit is destined.

- Supplied accessories
  - AC power cord
  - Remote commander RC-23

\* Specifications and design subject to change without notice for improvements.

## GUARANTEED SPECIFICATIONS

[Guaranteed specifications are measured according to EIA standard RS-490.]

<b>Continuous Average Output Power</b>	115 watts per channel into 4 ohms 105 watts per channel into 6 ohms 90 watts per channel into 8 ohms (both channels driven, 20 - 20,000 Hz)														
<b>Total Harmonic Distortion</b>	0.04%, with 4 to 16 ohms load (both channels driven, 20 - 20,000 Hz)														
<b>Intermodulation Distortion</b>	0.01%														
<b>Frequency Response</b>	HIGH LEVEL INPUT : 20 - 20,000 Hz +0, -0.2 dB (UNBALANCED/BALANCED, at rated continuous average output)														
<b>Damping Factor</b>	110 (with 8-ohm load, 50 Hz)														
<b>Input Sensitivity, Input Impedance</b>	<table border="1"> <thead> <tr> <th rowspan="2">Input</th> <th colspan="2">Sensitivity</th> <th rowspan="2">(EIA) Input Impedance</th> </tr> <tr> <th>For rated output</th> <th>For 1 W output</th> </tr> </thead> <tbody> <tr> <td>HIGH LEVEL INPUTS</td> <td>213 mV</td> <td>22.5 mV</td> <td>20 k Ω</td> </tr> <tr> <td>BALANCED INPUTS</td> <td>213 mV</td> <td>22.5 mV</td> <td>40 k Ω</td> </tr> </tbody> </table>	Input	Sensitivity		(EIA) Input Impedance	For rated output	For 1 W output	HIGH LEVEL INPUTS	213 mV	22.5 mV	20 k Ω	BALANCED INPUTS	213 mV	22.5 mV	40 k Ω
Input	Sensitivity		(EIA) Input Impedance												
	For rated output	For 1 W output													
HIGH LEVEL INPUTS	213 mV	22.5 mV	20 k Ω												
BALANCED INPUTS	213 mV	22.5 mV	40 k Ω												
<b>Gain</b>	HIGH LEVEL INPUT → OUTPUT: 42 dB (UNBALANCED/BALANCED)														
<b>Tone Controls</b>	Turnover frequency and adjustment range BASS : 300 Hz ±10 dB (50 Hz) TREBLE : 3 kHz ±10 dB (20 kHz)														
<b>Loudness Compensation</b>	+6 dB (200 Hz) (Volume control setting -30 dB)														
<b>Signal-to-Noise Ratio (input-converted noise)</b>	<table border="1"> <thead> <tr> <th>Input</th> <th>Input shorted, IHF-A weighting</th> <th>S/N ratio (EIA)</th> </tr> </thead> <tbody> <tr> <td>HIGH LEVEL INPUTS</td> <td>110 dB</td> <td>81 dB</td> </tr> <tr> <td>BALANCED INPUTS</td> <td>92 dB</td> <td>81 dB</td> </tr> </tbody> </table>	Input	Input shorted, IHF-A weighting	S/N ratio (EIA)	HIGH LEVEL INPUTS	110 dB	81 dB	BALANCED INPUTS	92 dB	81 dB					
Input	Input shorted, IHF-A weighting	S/N ratio (EIA)													
HIGH LEVEL INPUTS	110 dB	81 dB													
BALANCED INPUTS	92 dB	81 dB													
<b>Power Level Meters</b>	Logarithmic compression, peak reading meters, dB and direct watt-reading (8-ohm load) scale														
<b>Load Impedance</b>	4 - 16 ohms														
<b>Stereo Headphones</b>	Suitable impedance: 4 - 100 ohms														
<b>Power Requirements</b>	100 V, 120 V, 220 V, 230 V, 240 V (Voltage as indicated on rear panel) AC, 50/60 Hz														
<b>Power Consumption</b>	30 watts idle 220 watts in accordance with IEC-65														
<b>Maximum Dimensions</b>	Width 475 mm (18-11/16") Height 150 mm (5-7/8") Depth 422 mm (16-5/8")														
<b>Weight</b>	18.5 kg (40.8 lbs) net 23.5 kg (51.8 lbs) in shipping carton														
<b>Supplied Remote Commander RC-23</b>	Remote control principle : infrared pulse Power supply : 3 V DC (IEC R6 batteries x 2) Dimensions : 45 (width) x 136 (height) x 18 (depth) mm Weight : 85 g (including batteries)														