

# Accuphase

## P-400

STEREO POWER AMPLIFIER



- 200W/50W/ch. (PURE CLASS-A)
- MOS FET OUTPUT STAGE
- OPERATION CONTROL SWITCH

The Accuphase P-400 is a highest grade stereo power amplifier which forms a perfect combination with the highly regarded Accuphase C-240 Control Center. The P-400 employs MOS FETs (Metal-Oxide Semiconductor FETs), considered the most promising active device for power amplifier applications, in a triple push-pull output stage that delivers the high power of 200 watts per channel.

One of the main features of the P-400 is that the advantages of minimum distortion offered by pure Class-A amplifier operation can be enjoyed by switch control. Class-A operation offers a higher degree of perfection in amplification characteristics, especially in the high frequency range. In addition, the use of MOS FETs in the P-400 ensures a complete absence of notching distortion.

Although output power falls to 50 watts per channel during Class-A operation, it is adequate to drive medium efficiency speakers, rated around 90dB/W/m, with ample sound pressure.

The P-400 employs the "Accuphase Original" complementary-symmetry push-pull, DC Servo Controlled amplifier circuitry. It is designed to deliver highest grade sound reproduction with its pure monophonic type construction which features completely separated, independent power supplies for its left and right channels.

## 1 PURE CLASS-A OPERATION

Pure Class-A amplifier operation is offered by the P-400 to minimize distortion and achieve further perfection of sound reproduction quality in response to the constant search of hi-fi enthusiasts for better sound. Another reason is the fact that conventional power amplifiers which ordinarily employ Class-B or Class-AB amplification have about reached their respective theoretical performance limitations.

When the P-400 is switched to Class-A mode, the operating slopes of its push-pull devices perfectly overlap each other as they should in pure Class-A operation. This means that operational and thermal stability is maintained at all times because constant energy flows from its power supplies to the amplifying devices.

This improved stability is another big advantage of pure Class-A operation, since widely fluctuating signals cause no change of current and thermal conditions in the amplifying devices as they do in Class-B or AB operation, with their attendant distortion problems. Therefore, the advantages of pure Class-A operation, as applied in the P-400 with its perfectly matched operational MOS FETs, ensure the highest state of the art in sound reproduction performance, and far outweigh the disadvantage of reduced output power for ordinary listening.

Switching to Class-A mode is achieved electronically, not mechanically, with a bias circuit selecting system.  $Q_{12}$  and  $Q_{13}$  in the amplifier block diagram of Figure 1 shows how this is done.  $Q_{12}$  is a transistor which activates the bias resistor "VR" ON or OFF.  $Q_{13}$  is an Opto-Coupler which controls  $Q_{12}$ . It includes a photo transistor and a light emitting diode.  $Q_{13}$  is inactive during NORMAL mode, so  $Q_{12}$  goes ON to short the bias resistor VR out of the circuit for the normal, high power operation of the driver and final output stages.

When the OPERATION switch is set to CLASS-A mode, current

flows through the Light Emitting Diode (LED) and activates the Photo Transistor  $Q_{13}$ . This turns  $Q_{12}$  OFF and activates resistor VR of the bias circuit, which causes Class-A amplification bias current to flow through the drive and final output stages. It also simultaneously lowers the B voltage applied to the output MOS FET devices for Class-A operation. Transistors  $Q_1$  to  $Q_9$  operate at all times as Class-A amplifiers. Very stable operation is achieved in this manner since operational mode switching is accomplished without moving the signal path circuit around excessively.

The OPERATION switch on the front panel controls the selection of Normal or Class-A operation, and the LED lamps will be coincidentally switched over to indicate operation mode.

## 2 MOS FET OUTPUT STAGE

The output stage employs MOS FET devices, which are regarded as most ideal for power amplifier applications, in a triple push-pull circuitry. MOS FETs possess many characteristics that make them more suitable than bi-polar or SIT (V-FET) transistors for this function. They significantly improve high frequency performance characteristics since they do not cause notching distortion. They also effectively reduce harmful transient intermodulation distortion because of their wide frequency range characteristics. In addition, MOS FETs assure improved overall performance since they are high gain, voltage controlled devices which fact simplifies Class-A amplifier design for the preceding driver amplifier stages.

## 3 SERVO CONTROLLED DC AMPLIFIER

The complete elimination of input capacitors and large capacitors in the NF loop has made the P-400 a true DC amplifier that assures minimum coloration of sound. A DC Servo Control system was adopted to achieve this, and eliminate all DC drift at the output and prevent passage of DC current. Otherwise, any DC leakage from the preamplifier would be amplified in the final stage and pass on to cause damage to the speakers.

The two integrated circuits (ICs) in Figure 1 make up the DC Servo Control circuitry. It detects and amplifies any DC voltage that may appear at the output. It uses this energy to control the gate voltage of  $Q_{1b}$ , the input differential amplifier circuit of the Servo Control circuitry. For example, if a DC + current should appear at the output, it would cause the bias voltage of  $Q_{1b}$  also to turn positive, which in turn causes a reduction in the DC potential at the output. This process repeats itself until DC output potential is "0", which is maintained by the Servo Control system at all times.

## 4 COMPLEMENTARY-SYMMETRY PUSH-PULL AMPLIFIERS IN EVERY STAGE

Every amplifier stage employs a complementary-symmetry push-pull circuitry, which is an "Accuphase Original." This circuit has superior inherent characteristics and requires minimum application of negative feedback (NFB), particularly because of its outstanding linearity. This accounts for its extremely low distortion ratio and high amplification stability. This also prevents TIM (transient intermodulation) distortion and ensures a big improvement in the quality of sound reproduction.

Distortion data are shown in the last page, and Fig. 2 shows the IM Distortion data under new IHF Standard Methods of Measurement defined in 1978.

When plural signals closed each other in frequency cause non-linear distortion, as well as harmonic distortion of each original signals, a third signal of difference in frequency between each signals appears and deteriorates the reproduction sound. This is the process of the IM Distortion stated in the new IHF. This distortion is occasionally called as BEAT DISTORTION. Even if original signals are out of the audible range, such a distorted third signal comes to appear in the audible range and it results in a deterioration of sound quality. This became a great issue recently. This kind of IM Distortion is apart from the former Intermodulation Distortion which is measured with the frequencies of 50Hz or 60Hz vs 7,000Hz and is called as "SMPTE-IM".

Refer to Fig.2. It shows the distortion spectrum of the P-400 which

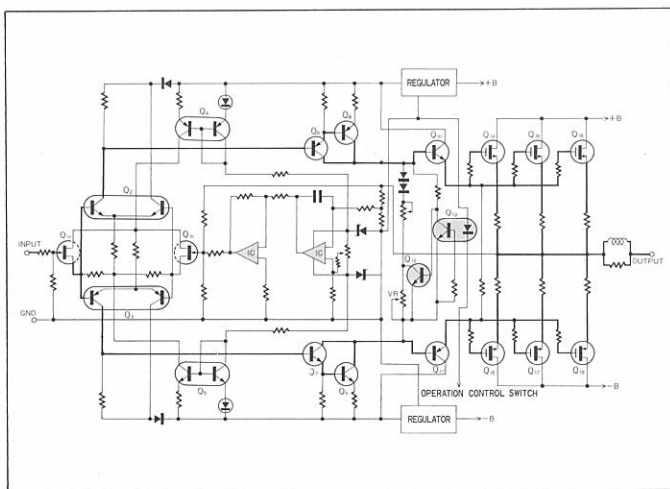
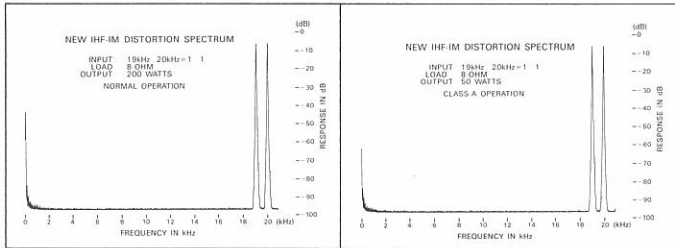

Fig.1 MOS FETs' SYMMETRICAL PUSH-PULL DC POWER AMP.

# Accuphase P-400

STEREO POWER AMPLIFIER

was measured under the condition at rated output, with input signals in frequencies of 19kHz and 20kHz at the rate of 50 to 50. If the IHF-IM Distortion has been caused in the P-400, a spectrum appears at the frequencies of 1kHz, 2kHz, 3kHz and so on. The Fig. 2 attests the truth that none of IM Distortion have been detected and any distortion are out of measuring limit of 0.0027%.



(A) NORMAL OPERATION (B) CLASS-A OPERATION

Fig. 2 NEW IHF-IM DISTORTION SPECTRUM

## 6 SEPARATE POWER SUPPLY FOR EACH CHANNEL

Although good performance can be obtained with a single power supply for both channels when a sufficiently heavy duty power transformer and large filter capacitors with high capacitances are used, the P-400 is equipped with independent power supplies for each channel to ensure a higher degree of perfection.

Each power supply has its own power transformer and two 33,000 $\mu$ F filter capacitors. New C-I core type power transformers, recognized for their high efficiency and excellent regulation characteristics, are employed together with giant capacitors to form very powerful and stable power supplies, one each for the right and left channels.

## 6 PEAK LEVEL METER WITH "PEAK HOLD" FEATURE

A Power Meter is provided on the front panel which is very convenient also for monitoring output level. It is a logarithmic type peak level meter which permits direct reading of output level in decibels (dB) and power output into an 8-ohm load in watts.

The meter also offers a PEAK HOLD feature when the METER FUNCTION switch is used. It will hold the pointer at peak level for a sampling period of three seconds which is very convenient for observing program source peaks. Whenever the OPERATION switch is used for Class-A operation, the meter pointer will thereafter automatically register "0" dB for the rated output of 50 watts.

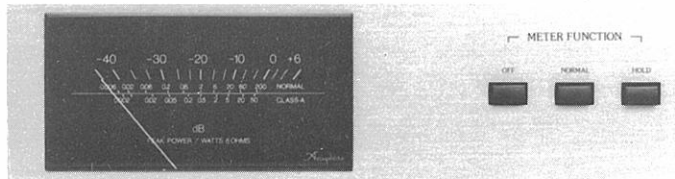

## 7 1 dB STEP ATTENUATOR

This power amplifier provides step attenuation of input levels so that the overall sound pressure level can be controlled in accordance with total efficiency, including that of the speaker. Independent, variable control of the left and right channels is possible down to -20dB in one dB steps. This feature is most convenient for multi-amplification systems.

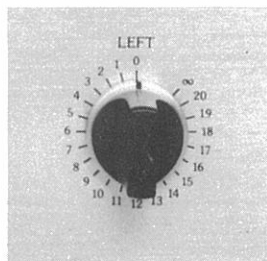

## 8 THERMO CONTROLLED VENTILATION FAN

Heat equivalent to about 300 watts is generated normally during Class-A operation so a ventilation fan is provided for its dissipation to ensure long life service of the active devices. As soon as the regular operating temperature is reached, a heat sensor that is connected to the ventilation fan will automatically control fan speed so that the blade will revolve faster in direct ratio to any further rise in temperature.

## 9 PROTECTION CIRCUIT SAFEGUARDS AGAINST OVERHEATING

The P-400 is equipped with a Protection circuit as a further safeguard against overheating which may result if the unit is installed in a poor location with extremely bad ventilation. If the heat sink temperature should rise to 100 degrees centigrade in such a case during Class-A operation, the heat sensor protection circuit will automatically change Class-A bias to normal bias. If overheating should occur during NORMAL operation, the heat sensor protection circuit will automatically reduce the B voltage to the power output FETs.

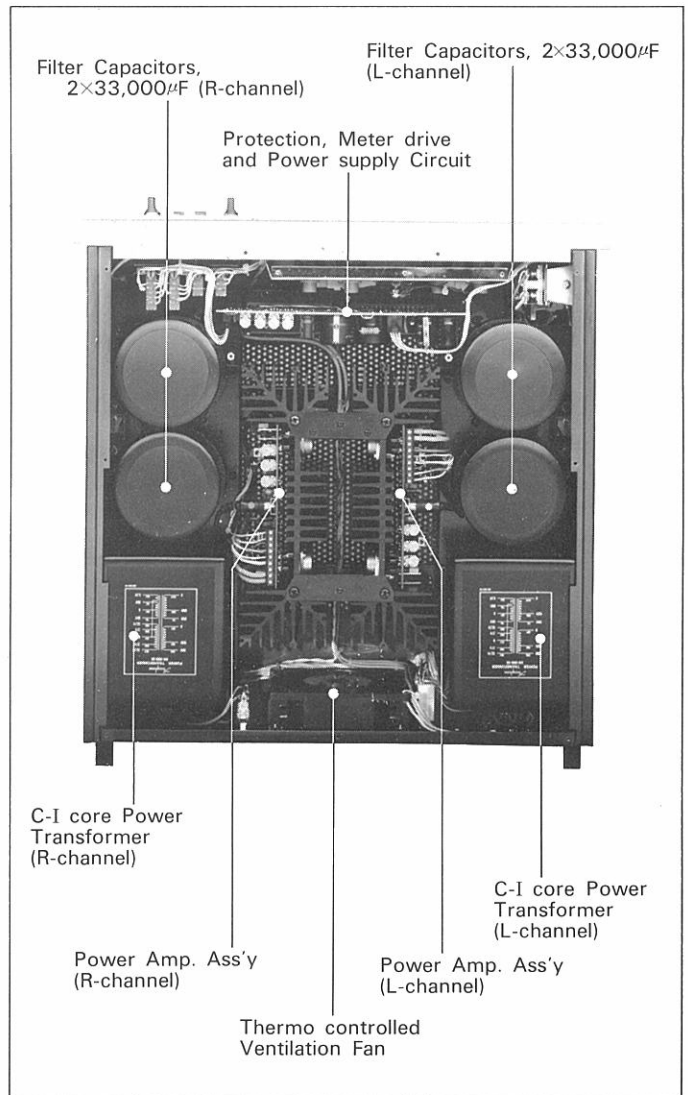

# Accuphase P-400

STEREO POWER AMPLIFIER

## GUARANTY SPECIFICATIONS

### PERFORMANCE GUARANTY:

All Accuphase product specifications are guaranteed as stated.

### CONTINUOUS AVERAGE POWER OUTPUT: (New IHF Standard)

both channels driven, from 20 Hz to 20,000 Hz with no more than 0.01% total harmonic distortion:

**NORMAL OPERATION:** 300 watts per channel, min. RMS, at 4 ohms  
200 watts per channel, min. RMS, at 8 ohms  
100 watts per channel, min. RMS, at 16 ohms

**CLASS-A OPERATION:** 80 watts per channel, min. RMS, at 4 ohms  
50 watts per channel, min. RMS, at 8 ohms  
25 watts per channel, min. RMS, at 16 ohms

### TOTAL HARMONIC DISTORTION:

both channels driven, from 20 Hz to 20,000 Hz at any power output from 1/4 watt to rated power:

0.01% max., at 4 ohms  
0.01% max., at 8 ohms  
0.01% max., at 16 ohms

**INTERMODULATION DISTORTION:** (New IHF Standard)  
will not exceed 0.003% at rated power output

**FREQUENCY RESPONSE:** (New IHF Standard)  
20 Hz to 20,000 Hz; +0, -0.2 dB for rated output at the maximum level control  
0.4 Hz to 250,000 Hz; +0, -3.0 dB for 1 watt output at the maximum level control  
0.4 Hz to 120,000 Hz; +0, -3.0 dB for 1 watt output at -6 dB attenuation

**DAMPING FACTOR:** (New IHF Standard)  
150, at 50 Hz

**INPUT SENSITIVITY AND IMPEDANCE:** 1.6V, 50k ohms, for rated output at the maximum level control  
0.12V, 50k ohms, for 1 watt output (New IHF Standard)

**A-WEIGHTED SIGNAL-TO-NOISE RATIO:** (Normal Operation)  
120 dB below rated output, inputs shorted  
100 dB at 1 watt output (New IHF Standard)

**POWER LEVEL METER:** logarithmic scale Peak Level indication of the dynamic range from -40 dB to +6 dB with Peak-Hold circuit, calibrated to read 0 dB at 200 watts into 8 ohms load

**SEMICONDUCTOR COMPLEMENT:** 34 Tr's, 20 FET's, 6 IC's, 54 Diodes, 2 opto-couplers, 2 Thermistors

**POWER REQUIREMENT:** Voltage Selector for 100V, 117V, 220V and 240V  
50/60 Hz operation

**CONSUMPTION:** NORMAL OPERATION  
110 watts at zero signal output  
690 watts at rated power output into 8 ohms load

CLASS-A OPERATION  
300 watts at zero signal output  
315 watts at rated power output into 8 ohms load

**DIMENSIONS:** 445 mm (17-1/2 inches) width, 160 mm (6-5/16 inches) max. height, 455 mm (17-15/16 inches) depth

**WEIGHT:** 31.2 kg (68.6 lbs.) net, 37 kg (81.4 lbs.) in shipping carton

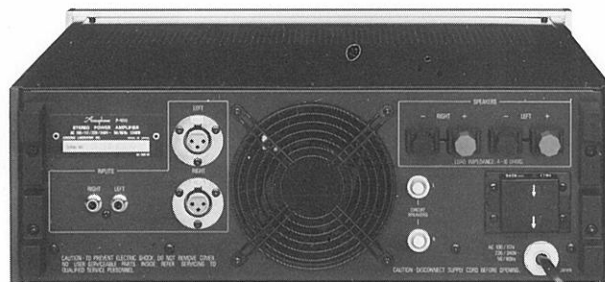
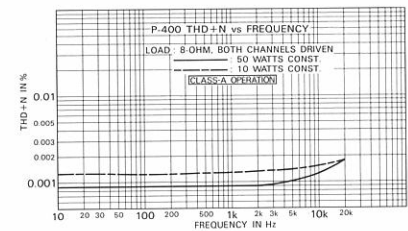
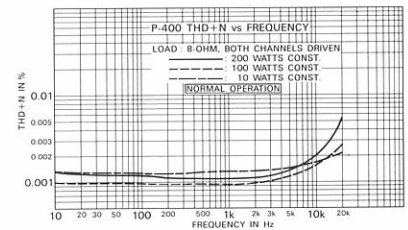
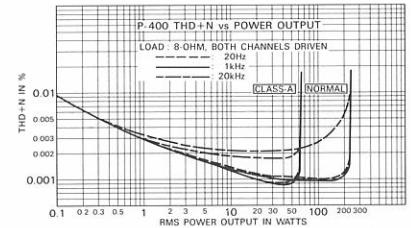
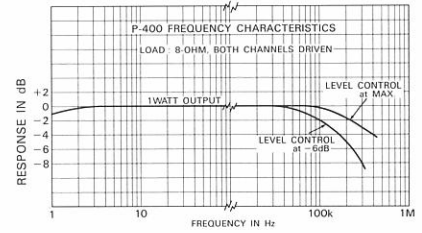

REAR PANEL VIEW

**Accuphase**  
ACCUPHASE LABORATORY INC.