

# Accuphase

STEREO POWER AMPLIFIER

## P-550

- 10-parallel push-pull output stage delivers 270 W/8 ohms × 2
- Current feedback amplifier design eliminates phase shifts
- Bridged operation as monophonic power amplifier possible
- Balanced inputs
- All signal paths gold-plated
- Oversize speaker terminals



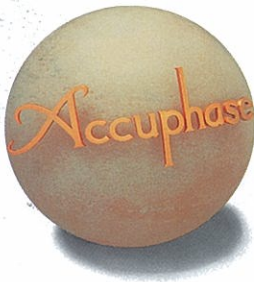

# Powerful and subtle—this amplifier makes music come alive. Current feedback design puts an end to phase shifts. Multi-emitter transistors in 10-parallel push-pull arrangement provide quality power: 270 watts per channel into 8 ohms, or 840 watts into 8 ohms monophonic mode.

If an amplifier is to accurately provide a large current to its load, that is to say a loudspeaker, there are two essential prerequisites: the power supply must be capable of delivering ample energy, and the high-current output stage must be designed with low impedance so that its operation is not adversely affected by the load. The latter requirement is especially important, because the impedance of a loudspeaker fluctuates considerably, depending on the frequency of the signal. Only an output stage with very low impedance will be able to assure accurate music reproduction under these demanding conditions.

To fulfill these demands, the P-550 employs multi-emitter type power transistors specially developed for high-power audio applications. These advanced devices have wide and flat frequency response, and their linearity of forward-current transfer ratio as well as their switching characteristics are excellent. With these transistors arranged in a 10-parallel push-pull configuration, the P-550 achieves an impressive power output rating of 270 watts into 8 ohms per channel. By using bridged mode, the P-550 can be turned into a monophonic power amplifier with an output of 840 watts into 8 ohms.

Another design highlight of the P-550 is the "current negative feedback" principle. As opposed to conventional voltage NFB designs, there is virtually no phase shift in the upper frequency range, and frequency response does not change when gain is altered. This new type of circuit therefore provides ideal amplification characteristics, combining operation stability with excellent frequency response. Phase compensation can be kept at a minimum, since only moderate amounts of NFB are required. This assures outstanding transient response, and the advantages are clearly audible as superb sonic realism and extraordinary detail resolution.

The basic source of energy for an amplifier is of course the power transformer and the filtering capacitors. Consequently, the sonic end

result depends to a considerable degree on how much of a performance margin is built into the power supply. The P-550 makes absolutely no compromises in this regard, featuring a large toroidal power transformer and enormous filtering capacity. And to maintain absolute sonic purity, all vital parts where the audio signal passes, such as the traces on the printed circuit boards and input and output terminals are gold-plated.

In the original Accuphase tradition, the P-550 features a champagne gold colored front panel made from heavy, 15-mm thick extruded aluminum with a hand-brushed finish. Its simple and uncluttered design gives the amplifier an elegant and sophisticated visual appeal.

## Powerful output stage with 10-parallel push-pull configuration delivers 550 watts into 2 ohms, 420 watts into 4 ohms, or 270 watts into 8 ohms per channel

The output stage uses multi-emitter type power transistors specially developed for audio applications and rated for a collector power dissipation of 130 watts and collector current of 15



ampere. These devices offer extraordinarily wide and flat frequency response, and their linearity of forward-current transfer ratio as well as their switching characteristics are outstanding. By arranging these transistors in a 10-parallel push-pull configuration, the P-550 achieves impressive power output capabilities, providing a full 550 watts into 2 ohms, 420 watts into 4 ohms, or 270 watts into 8 ohms per channel.

Figure 1 shows the output circuit configuration of the P-550. The driver stage employs power MOS-FETs with negative temperature coefficient.

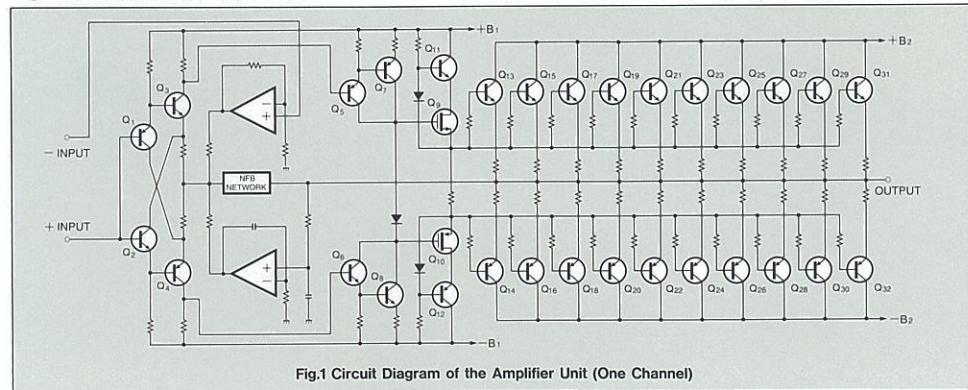

Fig.1 Circuit Diagram of the Amplifier Unit (One Channel)

These devices cancel out the positive temperature coefficient of the bipolar power transistors, which guarantees perfectly stable operation under all conditions.

## Current feedback circuit topology prevents phase shifts

When the gain of an amplifying circuit increases, frequency response, i.e. the bandwidth that can be handled by the amplifier, becomes more narrow. To counter this effect, a commonly employed technique called negative feedback (NFB) routes part of the output signal back to the input. If phase shift is disregarded, applying a high amount of NFB results in a circuit with high gain and wide frequency response, as shown in Figure 2.

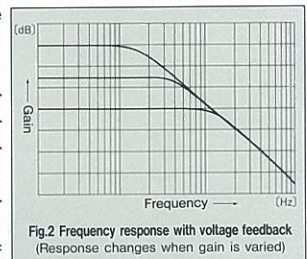

Fig.2 Frequency response with voltage feedback (Response changes when gain is varied)

Conventional amplifiers employ voltage NFB, whereby a fraction of the output voltage is used for the feedback loop. For the P-550, Accuphase developed a new type of feedback circuit topology which uses the signal current

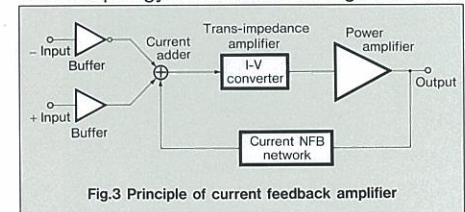

Fig.3 Principle of current feedback amplifier

rather than voltage. Figure 3 shows the operating principle of this circuit. At the input point of the feedback loop, the impedance is kept low and current detection is performed. A trans-impedance amplifier then converts the current into a voltage to be supplied to the output. Since the impedance at the current feedback point (current adder in Fig. 3) is very low, there is

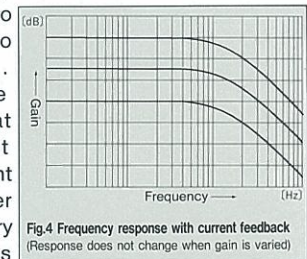

Fig.4 Frequency response with current feedback (Response does not change when gain is varied)

almost no phase shift. Phase compensation therefore can be kept at a minimum, resulting in excellent transient response and superb sonic transparency.

With this circuit, there is virtually no change in frequency response when gain is altered. Figure 4 shows frequency response for different gain settings of the current feedback amplifier. The graphs demonstrate that response remains uniform over a wide range.



**Bridged operation mode creates a true monophonic amplifier with 1,100 watts into 4 ohms and 840 watts into 8 ohms**

Bridged mode means that the two channels of an amplifier are driven with the same signal voltage but with opposite phase, and their output is combined. The P-550 provides a switch arrangement for bridged operation, which turns the unit into a high-grade monophonic amplifier capable of delivering a full 1,100 watts into 4 ohms and 840 watts into 8 ohms. Simply by adding another P-550 to form a stereo amplifier pair, a further dramatic improvement in sonic performance can be achieved.

**Balanced connection reliably blocks induced noise**

As illustrated by Figure 5, balanced signal transmission means that the output stage of a component supplies two signal lines, having identical voltage but opposite phase. On the input side, these signals are fed to a positive and negative amplifier circuit and then mixed. Since any noise interference that has arisen during transmission will be present in both lines with identical phase, such noise is canceled out, leaving only the pure signal. The longer the cable connections between audio components, the higher is the danger of external noise being introduced into the signal path, which invariably leads to sound quality degradation. The balanced connection principle reli-

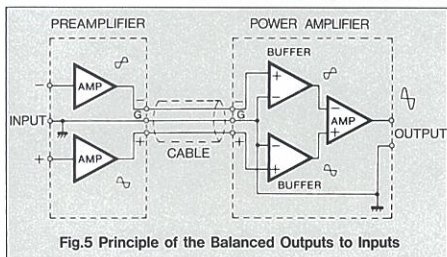

Fig.5 Principle of the Balanced Outputs to Inputs

ably prevents this danger, by keeping the signal transfer completely free from any kind of interference.

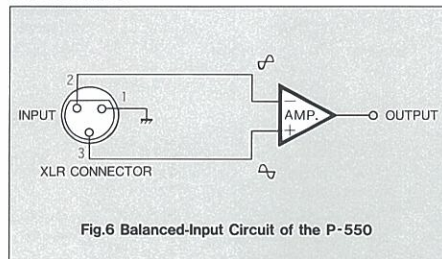
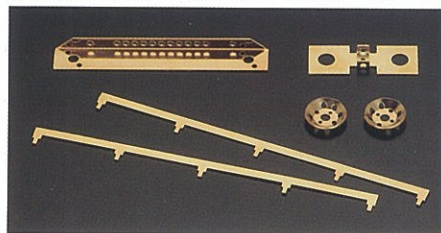

Fig.6 Balanced-Input Circuit of the P-550

In the P-550, as shown in Figure 6, the balanced signal is connected directly to inverting (+) and non-inverting (-) input stages, which results in ideal balanced operation.

**All signal paths are gold-plated**

High-purity copper is commonly used in signal path lines. The P-550 does this one better, by providing gold-plating. This includes not only



the copper traces on printed circuit boards but also ground bars carrying large ripple currents, bus bars providing current to the power transistors, input jacks, and speaker terminals. The input jacks with their high usage frequency have a coating that is 10 times thicker than on conventional jacks. This thorough approach results in a distinct sonic improvement.



**Robust power supply with large toroidal power transformer and high capacity of filter capacitors**

In any amplifier, the power supply plays a vital role as the source of energy for the entire unit. The P-550 spares no efforts in this regard, featuring a large, highly efficient 1,200 VA



toroidal power transformer. This transformer type is ideal for high-power amplifiers, since it is characterized by very low impedance, compact size, and very high conversion efficiency. In addition, two enormous electrolytic capacitors, each rated for 47,000 μ F/100 WV (electrical charge 4.7 Coulomb) provide more than ample filtering capacity for the rectified current.



**Large power meters, and speaker terminals compatible with banana plugs**

The large analog power meters let you easily monitor the output level. The oversize gold-plated speaker terminals accept even very heavy-gauge speaker cable, and it is also possible to insert banana plugs into the binding posts. Two switchable sets of outputs allow independent use or bi-wiring (supplying the same signal via dual leads to speakers with separate high-frequency and low-frequency inputs).



■ Power Amplifier Assembly (One Channel)

- 1 P-channel drive MOSFET
- 2 10-parallel PNP output transistors
- 3 Temperature compensation sensor transistor
- 4 Drive stage power supply filter circuit
- 5 Current feedback amplifier
- 6 Bridging relay
- 7 N-channel drive MOSFET
- 8 10-parallel NPN output transistors
- 9 Large aluminum heat sink

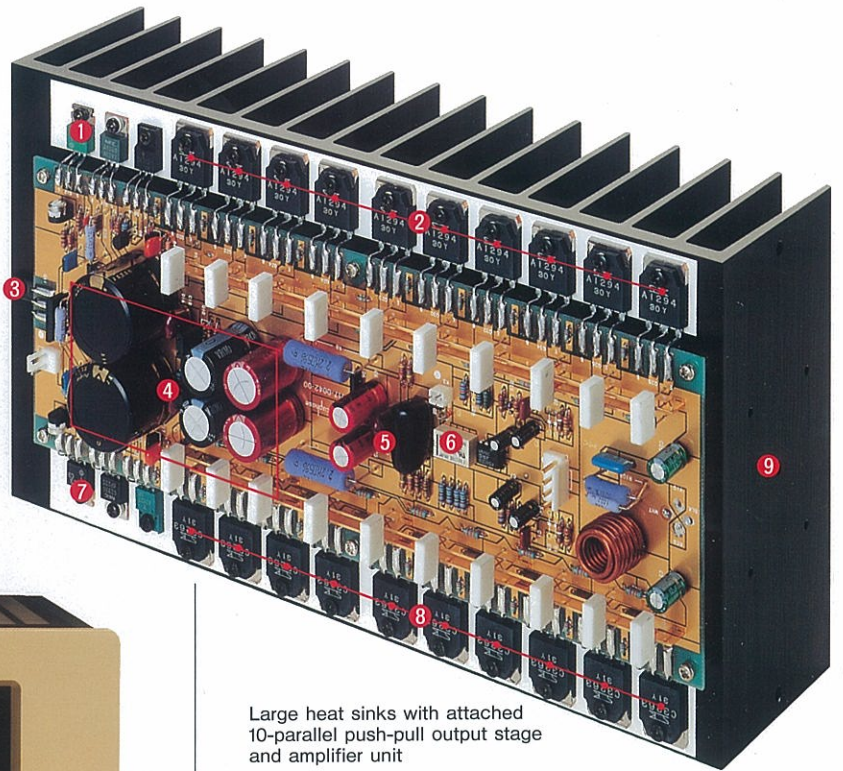

Large heat sinks with attached 10-parallel push-pull output stage and amplifier unit

■ FRONT PANEL

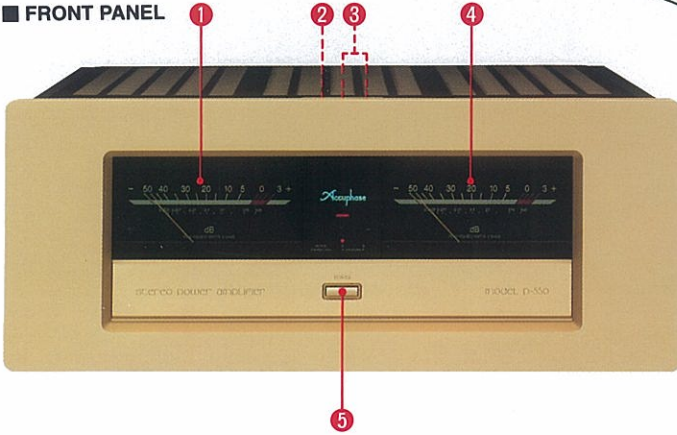

■ REAR PANEL



- 1 Left channel output meter (dB div., wattage direct reading)
- 2 Meter operation/light ON/OFF switch
- 3 Speaker selector: A, B
- 4 Right channel output meter
- 5 Power switch
- 6 Unbalanced input jack
- 7 (Balanced) input connectors. (1) Ground, (2) Inverted (-), (3) Non-inverted (+)
- 8 Input/bridge selector
- 9 Left and right channel output terminals for speaker systems A and B
- 10 Circuit breaker
- 11 AC connector (for supplied power cord)

**GUARANTEED SPECIFICATIONS**

(Guaranteed specifications are measured according to EIA standard RS-490)

- **Continuous Average Output Power (20 to 20,000 Hz)**
  - Stereo mode (both channels driven)
    - 550 watts per channel into 2-ohm load
    - 420 watts per channel into 4-ohm load
    - 270 watts per channel into 8-ohm load
  - Monophonic mode (bridging connection)
    - 1,100 watts into 4-ohm load
    - 840 watts into 8-ohm load
- **Total Harmonic Distortion**
  - Stereo mode (both channels driven)
    - 0.05%, with 2-ohm load
    - 0.02%, with 4-to 16-ohm load
  - Monophonic mode (bridging connection)
    - 0.02%, with 4-to 16-ohm load
- **Intermodulation Distortion**
  - 0.003%
- **Frequency Response**
  - 20 to 20,000 Hz, +0 dB, -0.2 dB (for rated continuous average output, level control at maximum)
  - 0.5 to 160,000 Hz, +0 dB, -3.0 dB (for 1 watt output, level control at maximum)
- **Gain**
  - 28.0 dB (in stereo and monophonic mode)
- **Output Load Impedance**
  - 2 to 16 ohms stereo mode
  - 4 to 16 ohms in monophonic mode (bridging connection)
- **Damping Factor**
  - 500 in stereo mode
  - 250 in monophonic mode (bridging connection)
- **Input Sensitivity (with 8-ohm load)**
  - Stereo mode
    - 1.85V (for rated continuous average output)
    - 0.12V (for 1 watt output)
  - Monophonic mode (bridging connection)
    - 3.26V (for rated continuous average output)
    - 0.12V (for 1 watt output)
- **Input Impedance**
  - Balanced: 40 k ohms
  - Unbalanced: 20 k ohms
- **Signal-to-Noise Ratio (A-weighted)**
  - 123 dB (input short circuit, rated continuous average output)
- **Power Level Meter**
  - Logarithmic compression, peak reading meters, dB and direct watt-reading (8-ohm load) scale
- **Power Requirements**
  - 100V, 120V, 220V, 230V, 240V (Voltage as indicated on rear panel) AC, 50/60 Hz
- **Power Consumption**
  - 200 watts at zero signal input
  - 980 watts in accordance with IEC-65
- **Maximum Outline Dimensions**
  - 475mm (18-23/32 inches) width,
  - 211mm (8-3/10 inches) height,
  - 444mm (17-12/25 inches) depth
- **weight**
  - 33.0kg (72.8 lbs.) net
  - 38kg (84 lbs.) in shipping carton

※Specifications and design subject to change without notice for improvements.

