

Accuphase

INTEGRATED STEREO AMPLIFIER

E-213

- MCS topology in preamplifier and power amplifier sections
- Parallel push-pull output stage delivers high quality power 90 watts × 2 into 8 ohms
- Current feedback principle in power amplifier combines superb sound with total operation stability
- Logic-control relays permit straight and short signal paths
- Option board slot provides capability for digital signal input and analog record playback





Featuring further improved MCS topology in preamplifier and power amplifier sections – Enjoy total sonic realism emerging from a background of utter silence. Wide-band power transistors in parallel push-pull configuration, working in conjunction with the rugged power supply deliver plenty of quality power: 115 watts per channel into 4 ohms or 90 watts into 8 ohms. Option board slot can be used to implement digital signal input for even better CD reproduction or analog record playback with impeccable quality.

The integrated amplifier series E-200 enjoys an enviable reputation, both in Japan and abroad. The E-213 embodies the sophisticated design concept of this series while featuring latest circuit topology and top quality materials. This results in further improved sound from an integrated amplifier that excels in all aspects. It brings out the inherent qualities of the source with total fidelity. Embark on a journey of musical discovery and discover the sheer beauty of sound.

An integrated amplifier offers various advantages such as convenient operation and modest space requirements. However, because its overall gain is very high, even the slightest interference or crosstalk at the input can have a considerable effect on the sonic result. To preclude this possibility, the E-213 is designed to achieve total electrical and structural separation of the preamplifier and power amplifier sections. These two parts operate as if they were entirely separate components, which significantly enhances the purity of sound. An EXT PRE switch and dedicated inputs even allow independent use of the power amplifier section.

Both the preamplifier and power amplifier use the proprietary MCS (Multiple Circuit Summing) principle developed by Accuphase, which significantly improves S/N ratio and other vital parameters. In addition, the power amplifier section incorporates the highly acclaimed current feedback topology from Accuphase. This ensures excellent phase characteristics in the high frequency range, combining total operation stability with outstanding frequency response.

The power amplifier output stage adopts a parallel push-pull configuration of multi-emitter power transistors designed for high-power audio applications. The large power transformer in the power supply and plenty of filtering capacity sustain ample high-quality output power. The preamplifier section comprises features such as tone controls, loudness compensator, and facilities for recorder connection. Each circuit component has been carefully selected after extensive tests. The end result is an integrated amplifier that clearly stands

out from the rest. An option board can be used to implement digital inputs or high-quality analog record playback.

Accuphase proprietary MCS topology in preamplifier and power amplifier stages

Both the preamplifier and power amplifier employ the MCS (Multiple Circuit Summing) topology

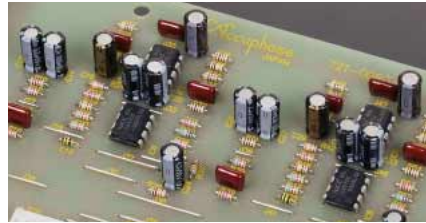

developed by Accuphase. This design results in significantly improved performance characteristics such as higher S/N ratio and lower distortion. In the power amplifier section (Figure 1), the same signal is supplied to two separate circuits, which also receive the feedback signal. After amplification, the output is then combined. In the preamplifier (line amplifier) as shown in Figure 2, a complete MCS

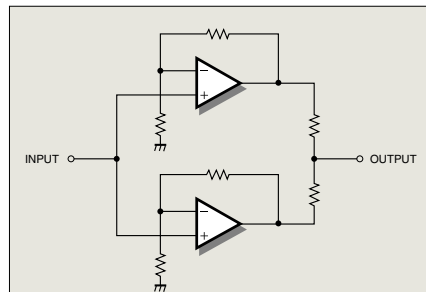
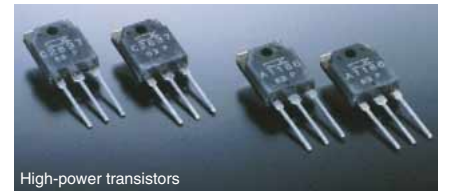

Fig. 2 Circuit diagram of line amplifier (one channel)

configuration is adopted with fully parallel operation of the entire amplification chain, not only a part of the stage. Mathematically, when using two parallel circuits, the improvement in S/N ratio is a full 3 dB.

Parallel push-pull power amplifier units deliver quality power: 115 watts/channel into 4 ohms or 90 watts/channel into 8 ohms

The output devices are multi-emitter power transistors designed for high power audio applications. These devices have excellent



High-power transistors

frequency response, forward-current transfer ratio linearity, and switching performance characteristics. They are connected in a parallel push-pull configuration and mounted directly on a large heat sink to assure efficient dissipation of thermal energy.

Current feedback circuit topology in the power amplifier section prevents phase shifts and assures excellent sound quality

In the power amplifier section of the E-213, the

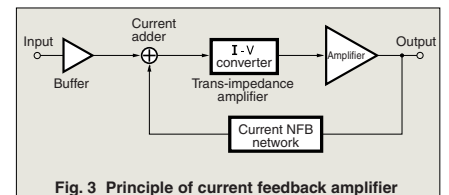

Fig. 3 Principle of current feedback amplifier

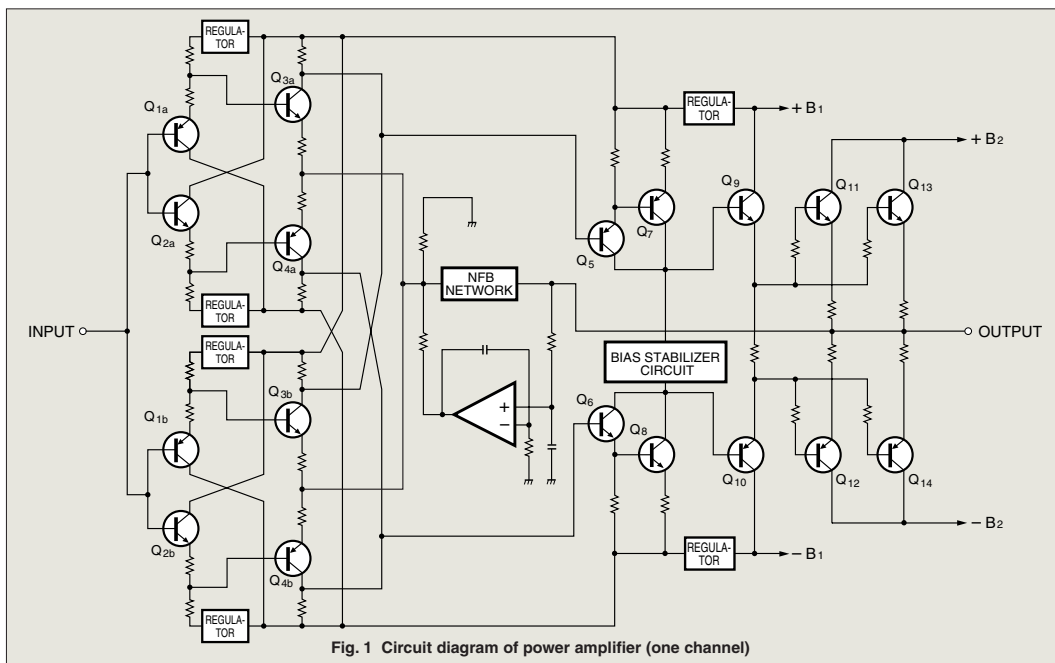

Fig. 1 Circuit diagram of power amplifier (one channel)

signal current rather than the more conventionally used voltage is used for feedback. Because there is almost no phase shift, phase compensation can be kept to a minimum, resulting in excellent transient response and superb sonic transparency. Furthermore, frequency response remains unchanged even when gain changes.

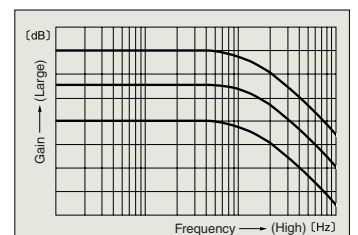

Fig. 4 Frequency response with current feedback
(Response remains uniform also when gain changes)

Figure 4 shows frequency response curves for different gain settings of the current feedback amplifier. It is evident that characteristics remain uniform over a wide range.



■ Supplied remote commander RC-23
Allows volume adjustment and input source switching



Power amplifier assembly with parallel push-pull output devices mounted to large heat sink, MCS circuit, and current feedback amplifier circuitry

Large power transformer and high filtering capacity

The E-213 features a large power transformer with a rating of 400 VA. The transformer is mounted in an enclosure filled with damping material that has excellent heat transfer characteristics. This design prevents unwanted interaction with the rest of the amplifier. Two massive electrolytic capacitors, each rated for 22,000 μ F, are used to filter the current. This ample performance margin of the power supply ensures dynamic sound down to very deep frequencies.



Highly reliable logic-controlled relays for best sound quality

Program source switching is performed by logic-controlled relays which are arranged so as to permit straight and short signal paths for enhanced sonic purity. The hermetically sealed relays are high-quality types developed specifically for demanding communication applications. The contacts are twin crossbar types plated with gold for minimum contact resistance and outstanding long-term reliability.



Gold-plated input/output jacks connected directly to relays

Tone controls use summing active filters for pure sound

The tone control circuitry in the E-213 features summing active filters. Figure 5 illustrates the operation principle of this circuit. The flat signal is passed straight through, and only when an adjustment is required, the characteristics created at F1 and F2 are added to the signal, thereby producing the desired change. This design provides efficient control without degrading signal purity.

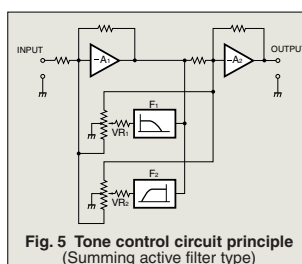

Fig. 5 Tone control circuit principle (Summing active filter type)

EXT PRE switch and power amplifier inputs allow separate use of power amplifier section

The preamplifier section and power amplifier section are designed as separate entities. A convenient EXT PRE switch and dedicated inputs make it easy to use the power amplifier of the E-213 on its own.



Two sets of heavy-duty speaker terminals

Two sets of oversize speaker terminals are provided which accept also heavy-gauge speaker cable.



Other Features

- Digital input and analog phono input can be implemented via option board
- Analog peak power meters
- High-quality volume control. Supplied remote commander allows source switching and volume adjustment
- "High Carbon" cast iron insulator feet with superior damping characteristics further enhance sound quality
- Loudness compensator restores natural balance at low listening levels

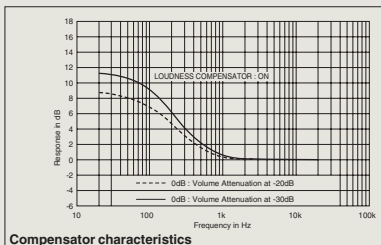

Compensator characteristics

Option Boards

The following three types of option boards are available for the E-213: Digital Input Board DAC-10, Analog Disc Input Board AD-9, and Line Input Board LINE-9.

Choose the board according to the intended usage, and install it in the convenient rear-panel slot. (Only one board can be used at a time.)

- The Analog Disc Input Board AD-10 and Line Input Board LINE-10 can also be used.



Digital Input Board

DAC-10

The board features an MDS (Multiple Delta Sigma) D/A converter and has inputs for coaxial and optical fiber connections.

A CD player, MD or DAT recorder or other component with digital output (sampling frequency range 32 - 96 kHz, 24 bit) can be connected to the board, for high-quality music reproduction.

Analog Disc Input Board

AD-9

This board contains a high-performance, high-gain phono equalizer.

● Internal DIP switches control MM/MC operation, MC input impedance, and subsonic filter on/off.

MM Gain: 36 dB
Input impedance: 47 kilohms

MC Gain: 62 dB
Input impedance: 10/30/100 ohms (selectable)

Line Input Board

LINE-9

This option board provides an additional set of conventional line inputs which can be used to connect a CD player, tuner, or other component with analog output.

Front panel

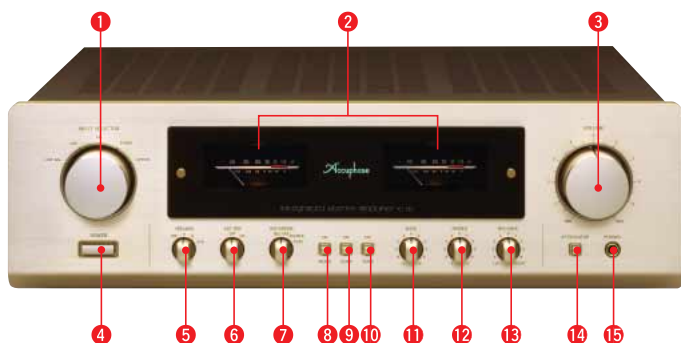

Rear panel



- | | |
|--|--|
| 1 Input selector
LINE-BAL LINE CD TUNER OPTION | 10 Tone control ON/OFF button |
| 2 Left/right channel output meters
(dB scale, direct-reading scale) | 11 Bass control |
| 3 Volume control | 12 Treble control |
| 4 Power switch | 13 Balance control |
| 5 Speaker selector OFF A B A+B | 14 Attenuator button |
| 6 EXT PRE (preamplifier/power amplifier separation)
ON/OFF switch | 15 Headphone jack |
| 7 Recording output selector
REC OFF SOURCE PLAY | 16 Line inputs (unbalanced) |
| 8 Stereo/mono button | 17 Line inputs (balanced) |
| 9 Loudness compensator switch | 18 Recorder REC/PLAY jacks |
| | 19 Power amplifier inputs |
| | 20 Left/right speaker output terminals A/B |
| | 21 AC inlet* |

Remarks

- * This product is available in versions for 120/230 V AC. Make sure that the voltage shown on the rear panel matches the AC line voltage in your area.
- * The shape of the AC inlet and plug of the supplied power cord depends on the voltage rating and destination country.

- Supplied accessories:
 - AC power cord
 - Remote Commander RC-23

GUARANTEED SPECIFICATIONS

[Guaranteed specifications are measured according to EIA standard RS-490.]

- **Continuous Average Output Power (both channels driven, 20 - 20,000 Hz)**
115 watts per channel into 4 ohms
105 watts per channel into 6 ohms
90 watts per channel into 8 ohms
- **Total Harmonic Distortion (both channels driven, 20 - 20,000 Hz)**
0.04%, with 4 to 16-ohm load
- **Intermodulation Distortion** 0.01%
- **Frequency Response**
POWER INPUT: 20 - 20,000 Hz 0, -0.2 dB
(for rated continuous average output)
2 - 150,000 Hz 0, -3.0 dB
(for 1 Watt output)
HIGH LEVEL INPUT: 20 - 20,000 Hz 0, -0.2 dB
(for rated continuous average output)
- **Damping Factor** 100 (with 8-ohm load, 50 Hz)
- **Input Sensitivity, Input Impedance**

Input	Sensitivity		Input impedance
	For rated output	For 1 W output (EIA)	
HIGH LEVEL INPUT	213 mV	22.5 mV	20 kΩ
BALANCED INPUT	213 mV	22.5 mV	40 kΩ
POWER INPUT	1.07 V	113 mV	20 kΩ

- **Gain**
HIGH LEVEL INPUT → OUTPUT: 42 dB
POWER INPUT → OUTPUT: 28 dB
- **Tone Controls**
Turnover frequency and adjustment range
BASS: 300 Hz ±10 dB (50 Hz)
TREBLE: 3 kHz ±10 dB (20 kHz)
- **Loudness Compensation** +6 dB (200 Hz) (Volume control setting -30 dB)
- **Attenuator** -20 dB
- **Signal-to-Noise Ratio**

Input	Input shorted (A weighting) S/N ratio at rated output	EIA S/N
HIGH LEVEL INPUT	110 dB	81 dB
BALANCED INPUT	92 dB	81 dB
POWER INPUT	123 dB	100 dB

- **Power Level Meters** Logarithmic compression, peak reading meters (Output dB / % scale)
- **Load Impedance** 4 - 16 ohms
- **Stereo Headphones** Suitable impedance: 8 - 100 ohms
- **Power Requirements** AC 120 V/230 V (Voltage as indicated on rear panel) 50/60 Hz
- **Power Consumption** 43 Watts idle
230 Watts in accordance with IEC-60065
- **Maximum Dimensions**
Width 475 mm (18-11/16")
Height 150 mm (5-7/8")
Depth 422 mm (16-5/8")
- **Mass** 18.8 kg (41.4 lbs) net
23.0 kg (50.7 lbs) in shipping carton
- **Supplied Remote Commander RC-23**
Remote control principle: Infrared pulse
Power supply: 3 V DC (IEC R6 batteries × 2)
Maximum dimensions: 45 (W) × 136 (H) × 18 (D) mm
Weight: 85 g (including batteries)



ACCUPHASE LABORATORY INC.

• Specifications and design subject to change without notice for improvements.

<http://www.accuphase.com/>

C0505Y PRINTED IN JAPAN 851-0145-00 (AD1)