

Accuphase

CLEAN POWER SUPPLY

PS-510

- AC voltage stabilizer based on waveform shaping technology
- Supplies up to 510 VA of extremely clean energy
- Low-distortion reference waveform generator
- Highly effective waveform compensation
- Outstanding current capability
- Superb interference rejection
- Built-in meter for monitoring five vital parameters: output power, input/output voltage, input/output distortion
- Elaborate protection features
- Large "Super Ring" toroidal transformer



The photograph shows the 230 V version.



Tap into a totally clean source of AC energy for up to 510 VA – Revolutionary waveform shaping technology enables highly precise compensation, creating a pure energy source of 230 V AC (or 120 V AC) $\pm 2\%$ with max. 0.22% THD. Connect audio or video equipment for a drastic improvement in sound and picture quality. Monitor output power (VA), input/output voltage (V), and input/output distortion (%) on the built-in meter.

The Clean Power Supply components from Accuphase are revolutionary products that remove noise and impurities from the AC power line and improve signal quality by continually monitoring and shaping the power supply waveform. They have been widely acclaimed for drastically improving the sound and picture quality of audio and video equipment. The PS-510 is an upgraded version that incorporates latest MCS+ circuit topology in the waveform compensation amplifier section. The reference signal generator features further improved accuracy to assure the lowest possible distortion in the output waveform.

The PS-510 uses waveform shaping technology to turn the power from a regular AC outlet into a highly pure sine waveform for use as a stable and uncontaminated energy source of A/V components. To achieve this, the PS-510 takes the power source waveform and compares it to a highly accurate and stable reference waveform. Based on this comparison, it then adds or subtracts exactly the required amount of correction. The compensation required by this innovative technique typically is only a fraction of overall power. The PS-510 therefore operates with high efficiency and produces little heat, allowing it to be designed as a fairly compact and lightweight unit. Since all circuitry is analog and there are no oscillators or switches, the PS-510 itself does not act as a source of spurious high-frequency noise.

Power Supply Waveform and Clean PS-510 Output Waveform

Almost all electrical devices used in a household convert the AC supplied by the outlet into a DC current for powering internal circuits. This task is performed by a rectifier. As shown in photograph (a), the rectifier load current has a pulse waveform with a large current flowing momentarily in the vicinity of the voltage peak.

This causes a voltage drop, resulting in clipping of the voltage waveform, as shown in photograph (b). A clipped waveform with a high amount of distortion contains many unwanted frequency components, or harmonics, as shown below. When entering the audio circuitry of an amplifier through the power supply, such harmonic components can interfere with the audio signal and cause intermodulation distortion which has a highly detrimental effect on sound quality.

When passing through the PS-510, the deformed waveform is restored to its original sine wave pattern (see frequency spectrum in the graph below). The result is a clean sine waveform as shown in photograph (c).

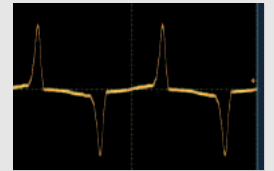
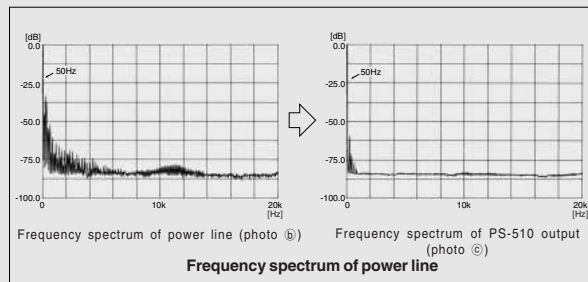

Photo (a) Current waveform of rectified load

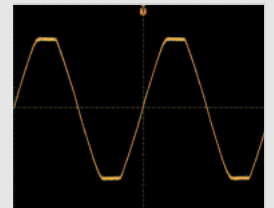

Photo (b) Voltage waveform of AC line (distortion approx. 3%)

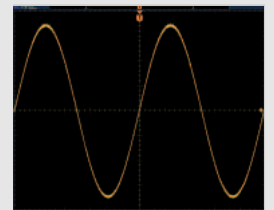

Photo (c) PS-510 output waveform (distortion approx. 0.22%)

AC Voltage Stabilizer Based on Waveform Shaping Technology

The PS-510 accepts AC power on the input side, processes it using internal control circuitry, and supplies it as clean AC power on the output side. Most of the AC energy from the input is carried over to the output. The loss introduced by the PS-510 is very small, since it consists only of the power required for waveform compensation.

As shown in Figure 1, the signal from the secondary winding S₁ of the transformer reaches the adding/subtracting circuit and appears at the output as output voltage (e_o). The S₂ signal from the transformer goes to the reference waveform generating circuit

where it becomes a high-precision sine waveform (e_i) synchronized to the input frequency of 50/60 Hz. This reference sine wave (e_i) is then used as reference signal to be compared to the output voltage.

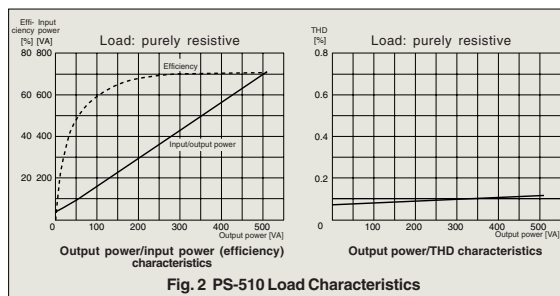

Fig. 2 PS-510 Load Characteristics

The differential component is extracted and used by the adding/subtracting circuit to provide exactly the required amount of compensation for turning the output into a high-precision sine waveform.

Highly Effective Interference Rejection

The input side of the PS-510 is equipped with a line filter for removing any high-frequency noise components present in the power line, such as generated by digital equipment. The primary and secondary windings of the power transformer are kept totally separate, and the fully shielded design shuts out any externally induced noise. Since the amplifier uses the feedback principle, output impedance is extremely low. This prevents any possibility of mutual interference between components connected to the outputs of the PS-510.

Built-in Meter Allows Monitoring of 5 Parameters: Output Power, Input/Output Voltage, Input/Output Distortion

The meter of the PS-510 lets the user see at a glance how much power (VA) the connected equipment is consuming at any given time. This is especially helpful for components such as integrated amplifiers or power amplifiers whose power consumption differs considerably depending on the volume setting and actual music signal. When the maximum rated output power of 510 VA is exceeded, the meter illumination flashes as a warning indication.

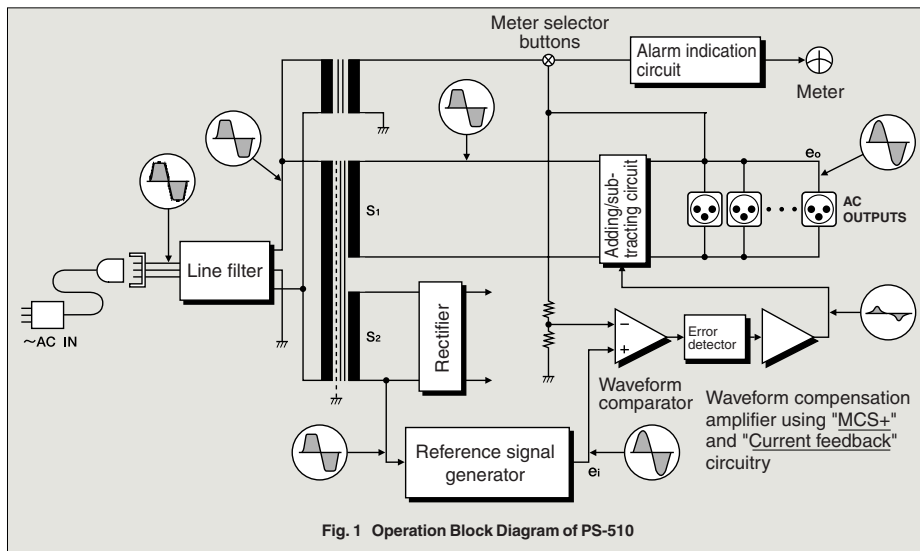
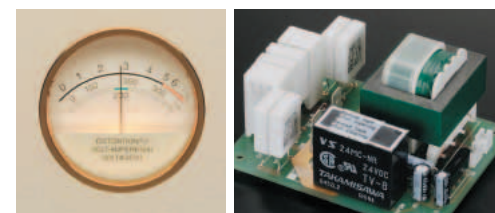

Fig. 1 Operation Block Diagram of PS-510



Meter of 230 V AC version

Assembly with input voltage/distortion monitoring circuitry



▼ Assembly with 10 parallel push-pull power transistors mounted to two large heat sinks, waveform compensation amplifier for addition/subtraction, etc.

Excellent Current Capability

The power amplifier which performs waveform compensation uses the current feedback principle for excellent high-frequency phase characteristics and operation stability. This is combined with the MCS+ circuit renowned for superior performance and sound quality. The output stage uses 10 transistors rated for a maximum current of 15 amperes. These devices are connected in a parallel complementary push-pull arrangement which boasts a rated output current of 2.2 A (4.2 A) and an instantaneous peak current (inrush current) rating of 30 A (60 A). This demonstrates the excellent current capability of the PS-510.

Note: The explanation is for the 230 V AC version of the PS-510. Figures in brackets refer to the 120 V AC version.

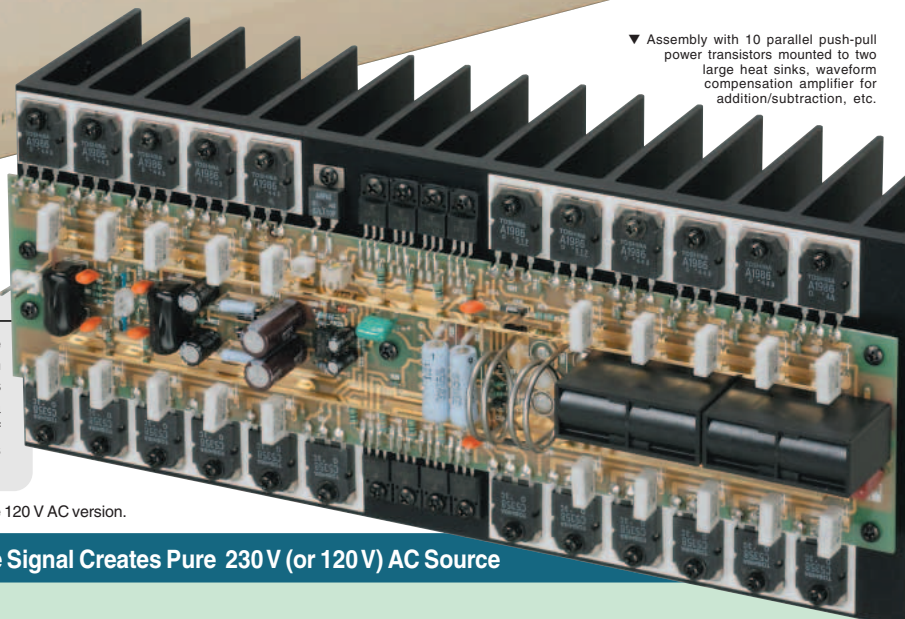

Compensation Amplifier Based on High-Precision Reference Signal Creates Pure 230 V (or 120 V) AC Source

Low-Distortion Reference Signal Generator

The waveform of the signal detected at the S_2 winding of the power transformer (see Fig. 1) is used by a highly precise Zener diode circuit to generate a square waveform. A newly developed 50/60 Hz bandpass filter and band-eliminate filter is then applied to the waveform. The filter frequency is switched in sync with the input frequency, for automatic 50 Hz and 60 Hz support. By routing the signal through another bandpass filter, a low-distortion sine wave (reference signal) is created that is not dependent on the input voltage.



■ Assembly with reference signal generator and other circuitry

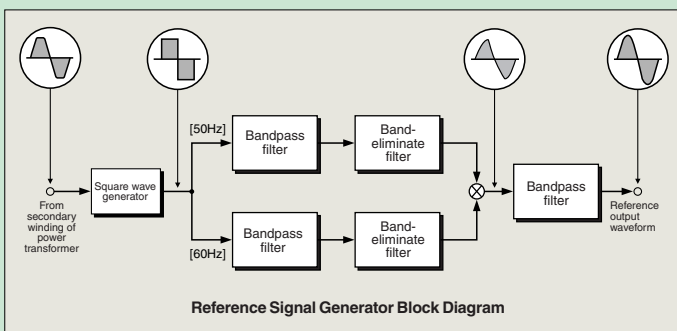

Superior Waveform Compensating Power

When the input voltage is 220 V (110 V), the voltage at the secondary side of the transformer will also be 220 V (110 V). To bring this to 230 V (120 V), 10 volts must be added, as shown in Figure (a). Conversely, if the input is 240 V (130 V), 10 volts must be subtracted to yield 230 V (120 V), as shown in Figure (b). (As the figures show, in actual operation, the peak value of 10 V, namely 14.1 V, is added or subtracted.) The sine wave (e) synchronized to the input frequency and the output voltage (e_o) are compared, and for any excessive or missing component, a compensation waveform up to a maximum of ± 10 V (peak value ± 14.1 V) is generated and imposed on the output voltage. Consequently, for an input voltage range of 200-253 V AC (108-132 V AC) at the rated load of 510 VA, the output voltage is kept constant at 230 V $\pm 2\%$ (120 V $\pm 2\%$), with a maximum distortion ratio of 0.22%. These values demonstrate the outstanding waveform compensation ability of the PS-510.

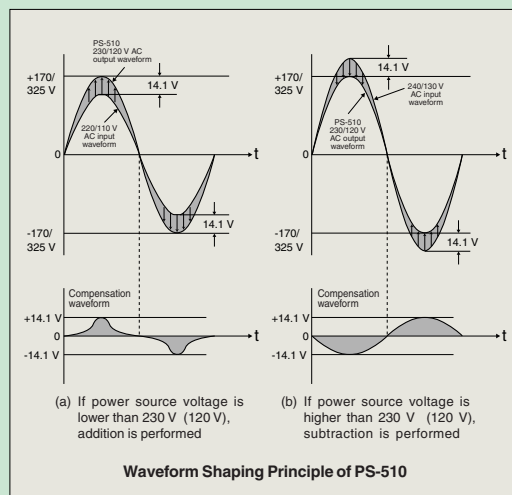

Multiple Protection Assures Total Operation Safety

If a problem occurs during operation, the circuit breaker immediately shuts off the power, to protect the unit and any connected components from possible damage.

- ① When the combined load of connected equipment exceeds the maximum rated output power of 510 VA, the meter illumination flashes as a warning indication.
- ② When input current overload occurs, the circuit protector shuts off the power. Reduce the connected load and turn power on again.
- ③ In case of momentary power overload such as caused by inrush current when a component is switched on or when a power amplifier reproduces a peak passage in the music, a current limiter becomes active to ensure safe use.



Circuit protector

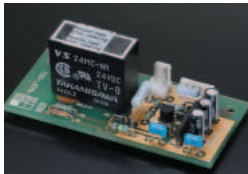

Assembly with protection circuitry

- ④ When DC voltage is detected in the output due to an operation problem or when the output voltage exceeds the maximum rating, the output is switched off to protect connected components.
- ⑤ When the temperature of the internal heat sink or power transformer is very high for an extended period, the circuitry is automatically shut down.

Strong Power Supply With Large "Super Ring" Toroidal Transformer and Two High-Quality 22,000 μ F Filtering Capacitors

The PS-510 uses a large toroidal type power transformer rated for about 750 VA. The "Super Ring" toroidal power transformer has large-gauge copper wiring on a donut-shaped core, resulting in very low impedance and high efficiency.



Gold-plated parts

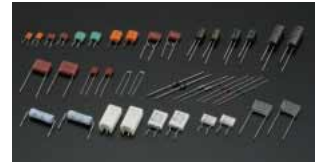

High-quality, high-reliability circuit components

Front panel

(The photograph shows the 230 V version.)

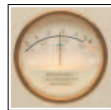
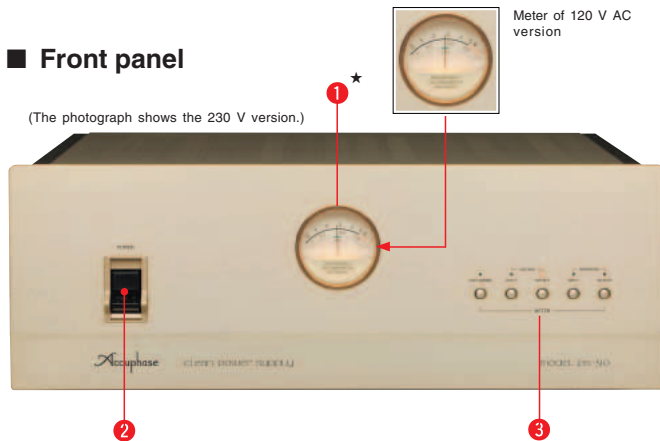

Meter of 120 V AC version

Rear panel

(The photograph shows the 230 V version.)

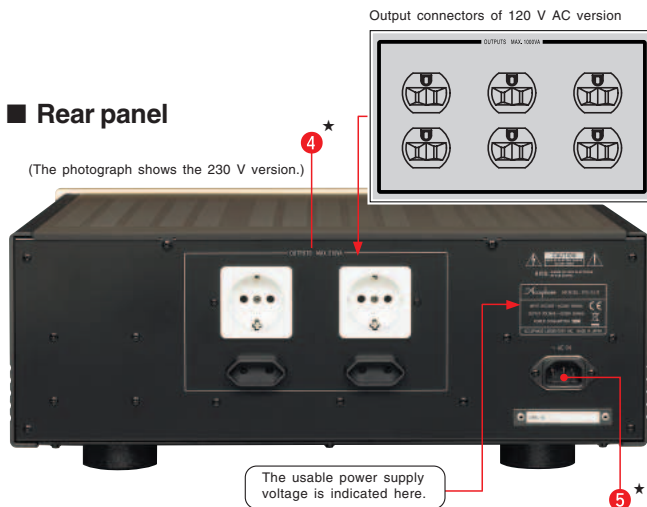

Output connectors of 120 V AC version

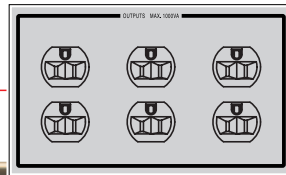

- ① Meter (Output power, input/output voltage, input/output distortion)*
- ② Power switch/circuit protector
- ③ Meter operation selector buttons
VOLT AMPERE (VA), VOLTAGE INPUT/OUTPUT (V)
DISTORTION INPUT/OUTPUT (%)
- ④ Output connectors (AC outlets)*
- ⑤ AC power connector*

Remark

* The 230 V AC and 120 V AC versions of the PS-510 differ regarding meter voltage indication, AC output connector shape, supplied power cord, etc. Make sure that you have the correct version.

PS-510 Meter (Power) Indication and Load

The power consumption of electrical equipment, as indicated on the equipment itself and in catalogs and other documentation according to legal requirements, is usually given in watts (W). This figure represents the so-called effective power. However, the actual power drawn by the equipment is larger than the effective power. This is called the apparent power which is calculated by multiplying the applied voltage (230 V or 120 V) with the actual current. The unit for apparent power is VA (Volt-Ampere).

Since the value shown by the meter of the PS-510 is the apparent power, the reading will be higher than the power consumption (W) given in catalogs and specification sheets.

- The rated power limit of the PS-510 is 510 VA. When deciding on equipment to be connected, select components so that the total remains within this limit, and check actual power consumption using the meter.
- High-output class-A power amplifiers, such as the A-60 or A-50V, which constantly draw a high idling current when switched on cannot be connected to the PS-510.
- In case of overload, the meter illumination flashes. Reduce the load by reducing the number of connected components until the illumination stops flashing and stays constantly lit.
- The power consumption of integrated amplifiers and power amplifiers varies considerably depending on the actual audio output. After connecting such equipment, perform playback and verify that power consumption does not exceed the maximum rating when peaks in the music are reproduced at high volume levels.

GUARANTEED SPECIFICATIONS

	120 V version	230 V version
Rated output capacity	510 VA (continuous)	
Rated output voltage	120 V AC ± 2.4 V	230 V AC ± 4.6 V
Rated output current	4.2 A	2.2 A
Instantaneous peak current capacity	60 A	30 A
Output frequency	50 Hz or 60 Hz (identical to input frequency)	
Output waveform THD	0.22% or less	
Rated input voltage	120 V AC	230 V AC
Input frequency	50 Hz or 60 Hz	
No-load power consumption	55 W	
Cooling principle	Natural air cooling	
Meter	0-510 VA * The meter illumination flashes when an overload occurs.	
VOLTAGE INPUT/OUTPUT (green zone of scale)	120 V AC $\pm 5\%$	230 V AC $\pm 5\%$
DISTORTION INPUT/OUTPUT	0-6%	
Maximum Dimensions	Width 465 mm (18-5/16") Height 181 mm (7-1/8") Depth 386 mm (15-3/16")	
Mass	23 kg (50.7 lbs.) net 29 kg (63.9 lbs.) in shipping carton	



Caution

- * The PS-510 is available in 230 V AC and 120 V AC versions. The actual allowable voltage is indicated next to the AC power connectors on the rear panel. Be sure to check this indication before using the PS-510.
- * This product can be used only on a regular household AC circuit rated for 230 V or 120 V AC, 50/60 Hz. Using the product with portable AC generators, airplane or marine power generators or other types of power sources is not possible.
- * This product is designed to improve the quality of AC power supplied to audio or video components. Do not use it to power industrial type equipment or common household electrical appliances.
- * Do not use this unit for powering equipment where failure incurs a risk of injury or fatal accidents (medical equipment, aviation equipment, traffic control equipment, furnace and heating control equipment, safety devices, etc.). Accuphase will not be liable for any problem occurring due to use of the PS-510 with the above type of equipment.

Supplied accessories: • AC power cord

Accuphase
ACCUPHASE LABORATORY, INC.

• Specifications and design subject to change without notice for improvements.

<http://www.accuphase.com/>

C0505Y PRINTED IN JAPAN 851-0155-00 (AD1)