

Accuphase

CLEAN POWER SUPPLY PS-1220

- AC voltage stabilizer based on waveform shaping technology
- Acts as a source of extremely clean energy
- Low-distortion reference waveform generator
- Highly effective waveform compensation
- Outstanding current capability
- Superb interference rejection
- Built-in meter for monitoring vital parameters including output power, input/output voltage, and input/output distortion
- Advanced protection features
- Large high-efficiency toroidal transformer
- Eight AC outlets



The photograph shows the 230 V version.

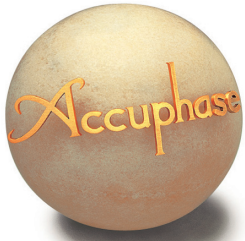

Tap into a totally clean source of AC energy — Revolutionary waveform shaping technology enables highly precise compensation, creating a pure energy source of 230 V AC ± 3 V (or 120 V AC ± 1.5 V) with max. 0.1% THD. Connect audio or video equipment for a drastic improvement in sound and picture quality. Monitor output power (VA), input/output voltage (V), and input/output distortion (%) on the built-in meter.

The Clean Power Supply components from Accuphase are revolutionary products that remove noise and impurities from the AC power line and improve signal quality by continually monitoring and shaping the power supply waveform. They have been widely acclaimed for drastically improving the sound and picture quality of audio and video equipment. The PS-1220 is an upgraded version that incorporates latest MOS-FET push-pull differential drive topology in the waveform compensation amplifier section. The reference signal generator features further improved accuracy and is linked to the power section by a balanced connection to assure the lowest possible distortion in the output waveform. The use of hospital grade AC outlets and matched output impedance assure optimum reliability. Because the PS-1220 can deliver as much as 1200 VA (230 V AC version) or 1000 VA (120 V AC version), it covers the requirements of

almost any high-quality A/V system currently on the market.

All signal circuits of the PS-1220 are analog, employing waveform shaping technology to turn the power from a regular AC outlet into a highly pure sine waveform for use as a stable and uncontaminated energy source for A/V components. To achieve this, the PS-1220 takes the power source waveform and compares it to a highly accurate and stable reference waveform. Based on this comparison, it then adds or subtracts exactly the required amount of correction to create a clean output waveform. The compensation required by this innovative technique typically is only a fraction of overall power. The PS-1220 therefore operates with high efficiency and produces only a low amount of heat. Since there are no oscillators or switches in the signal lines, the PS-1220 itself does not act as a source of spurious high-frequency noise.

AC Voltage Stabilizer Based on Waveform Shaping Technology

The PS-1220 accepts AC power on the input side, processes it using internal control circuitry, and supplies it as clean AC power on the output side. Most of the AC energy from the input is carried over to the output. The loss introduced by the PS-1220 is very small, since it consists only of the power required for waveform compensation.

As shown in Figure 1, the signal from the secondary winding S1 of the transformer reaches the adding/subtracting circuit and appears at the output as output voltage (e_0). The secondary winding S2 signal goes to the reference waveform generating circuit where it becomes a high-precision sine waveform (e_i) synchronized to the input frequency of 50/60 Hz. This reference sine wave (e_i) is then used as a reference signal to be compared to the output voltage.

The differential component is extracted and used by the adding/subtracting circuit to provide exactly the required amount of compensation for turning the output into a high-precision sine waveform.

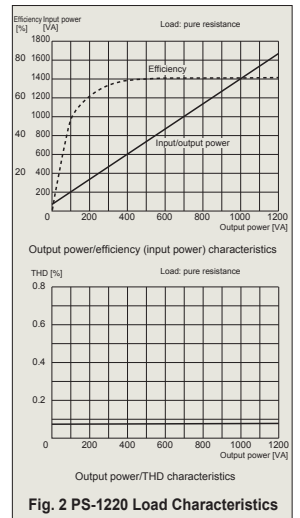

Fig. 2 PS-1220 Load Characteristics

Power Supply Waveform and Clean PS-1220 Output Waveform

Almost all electrical devices used in a household convert the AC supplied by the outlet into a DC current for powering internal circuits. This task is performed by a rectifier. As shown in photograph (a), the rectifier load current has a pulse waveform with a large current flowing momentarily in the vicinity of the voltage peak. This causes a voltage drop, resulting in clipping of the voltage waveform, as shown in photograph (b). A clipped waveform with a high amount of distortion contains many unwanted frequency components, or harmonics, as shown below. When entering the audio circuitry of an amplifier through the power supply, such harmonic components can interfere with the audio signal and cause intermodulation distortion which has a highly detrimental effect on sound quality. When passing through the PS-1220, the deformed waveform is restored to its original sine wave pattern (see frequency spectrum in the graph below). The result is a clean sine waveform as shown in photograph (c).

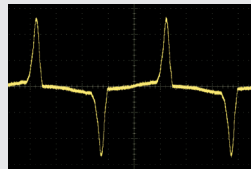

Photo (a) Current waveform of rectified load

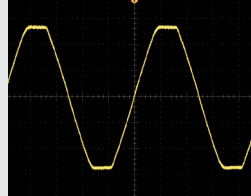
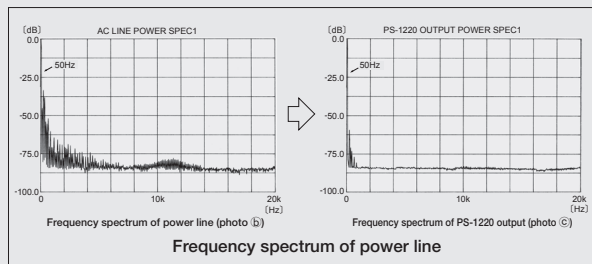

Photo (b) Voltage waveform of AC line (distortion approx. 3%)



Photo (c) PS-1220 output waveform (distortion approx. 0.06%)



Frequency spectrum of power line

Highly Effective Interference Rejection

The input side of the PS-1220 is equipped with a line filter for removing any high-frequency noise components present in the power line, such as generated by digital equipment. The primary and secondary windings of the power transformer are kept totally separate, and the fully shielded design shuts out any externally induced noise. Since the amplifier uses the feedback principle, output impedance is extremely low. This prevents any possibility of mutual interference between components connected to the outputs of the PS-1220.

Built-in Meter Allows Easy Monitoring of Output Power (VA), Input/Output Voltage (V), and Input/Output Distortion (%). Overload Indicated by Flashing LEDs.

The meter of the PS-1220 lets the user see at a glance how much power (VA) the connected equipment is consuming at any given time. This is especially helpful for components such as power amplifiers whose power consumption differs considerably depending on the volume. When the maximum rated output power (1200 VA for 230 V AC version or 1000 VA for 120 V AC version) is exceeded, the meter function selector LEDs flash as a warning indication.

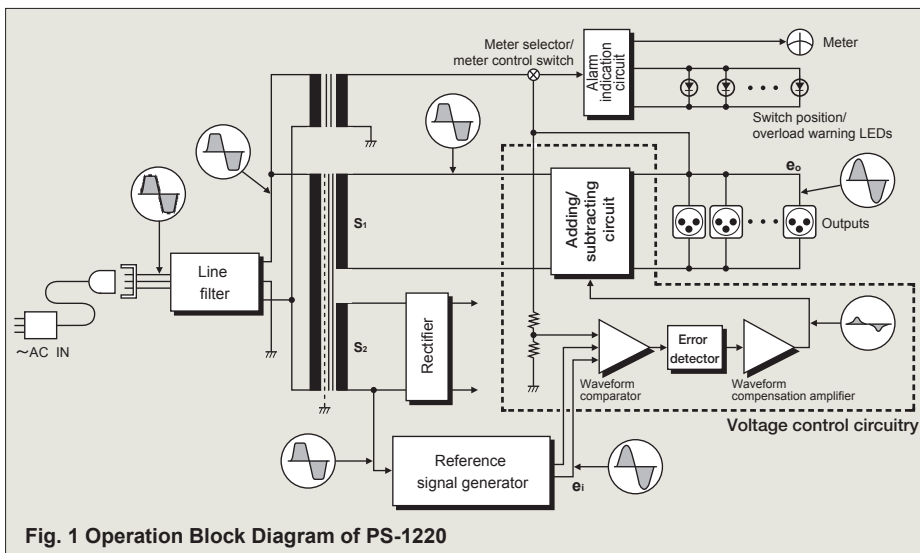
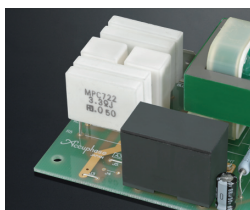

Fig. 1 Operation Block Diagram of PS-1220



Meter of 230 V AC version



Assembly with distortion

Compensation Amplifier Based on High-Precision Reference Signal Creates Pure 230 V (or 120 V) AC Source

Low-Distortion Reference Signal Generator

To generate the sine wave reference signal, the zero-cross point of the signal at the S2 winding of the power transformer (see Fig. 1) is detected by an OP amp and used by a high-precision Zener diode to generate a square waveform. A newly developed 50/60 Hz bandpass filter and band-stop filter are then applied to the waveform. The filter frequency is switched in sync with the input frequency, for automatic 50 Hz and 60 Hz support. By routing the signal through another bandpass filter, a low-distortion sine wave (reference signal) is created that is not dependent on the input voltage.

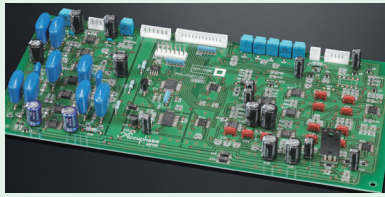

Assembly with reference signal generator and other circuitry

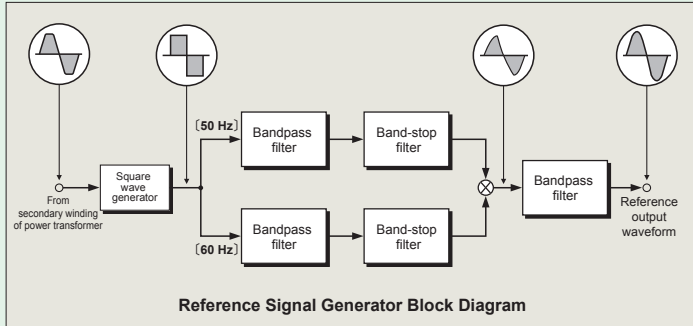

Superior Waveform Compensating Power

When the input voltage is 220 V (110 V), the voltage at the secondary side of the transformer will also be 220 V (110 V). To bring this to 230 V (120 V), 10 volts must be added, as shown in Figure 2 (a). Conversely, if the input is 240 V (130 V), 10 volts must be subtracted to yield 230 V (120 V), as shown in Figure 2 (b). (In actual operation, the peak value of 10 V, namely 14.1 V is added or subtracted.) The sine wave (ei) synchronized to the input frequency and the output voltage (eo) are compared, and for any excessive or missing component, a compensation waveform up to a maximum of ± 10 V (peak value ± 14.1 V) is generated and imposed on the output voltage. Consequently, for an input voltage range of 200-253 V AC (108-132 V AC) at the rated load of 1000 VA (1200 VA), the output voltage is kept constant at 230 V ± 3 V (120 V ± 1.5 V), with a maximum distortion ratio of 0.1%. These values demonstrate the outstanding waveform compensation ability of the PS-1220.

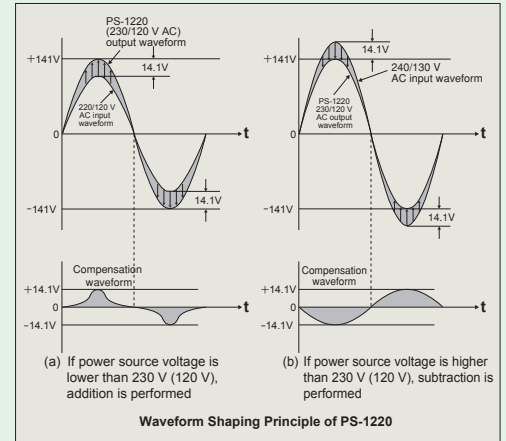

▼ Assembly with output stage using 20-parallel push-pull power MOS-FETs mounted to two large heat sinks, waveform compensation amplifier for addition/subtraction, etc.

Excellent Current Capability

The power amplifier which performs waveform compensation uses the pure complementary push-pull differential amplification principle for high raw gain, outstanding accuracy, and excellent operation stability. The final stage employs power MOS-FETs to reduce the load on the preceding stage and absorb sudden load fluctuations with ease. The result is constant and stable power, with high performance and ideal operation characteristics.

The power section is divided into two symmetrical parts with dedicated left and right heat sinks. Efficient cooling ensures stable operation for extended periods at high power.

The output stage uses 20 power MOS-FETs rated for a maximum current of 10 amperes. These devices are connected in a parallel complementary push-pull arrangement which boasts a rated output current of 12 A (8.3 A) and an instantaneous peak current (inrush current) rating of 60 A (120 A). This demonstrates the excellent current capability of the PS-1220.

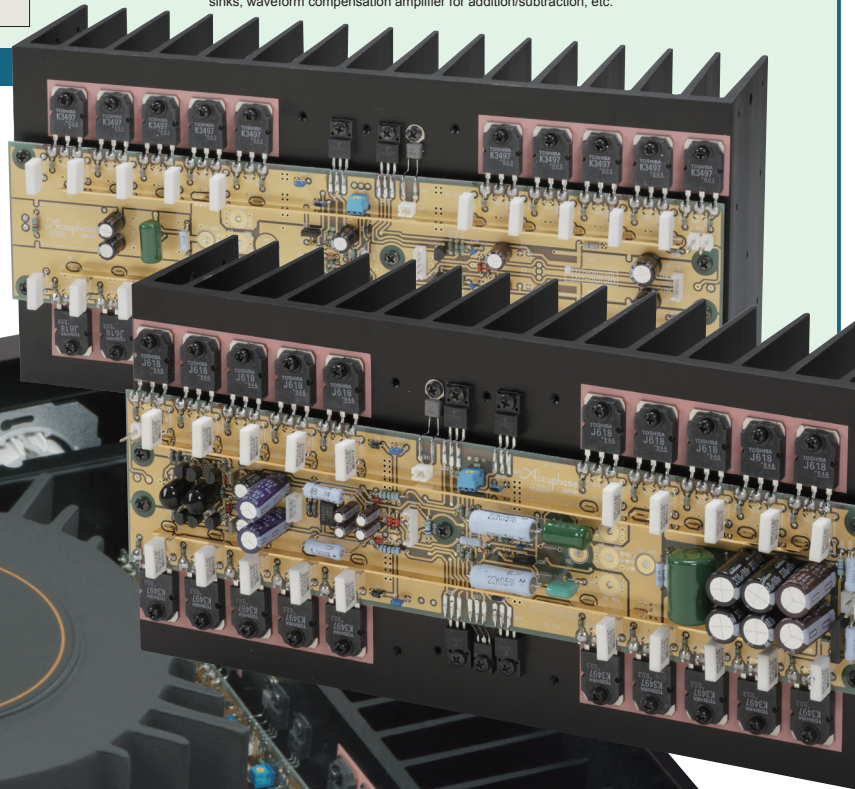

Input voltage/monitoring circuitry

The photograph shows the 230 V version.

Multiple Protection Assures Total Operation Safety

If a problem should occur during operation, the circuit breaker immediately shuts off the power to protect the unit and any connected components from possible damage.

- When the combined load of connected equipment exceeds the maximum rated output power (1200 VA for 230 V AC version or 1000 VA for 120 V AC version), the meter function selector LEDs flash as a warning indication.
- When input current overload occurs, the circuit protector shuts off the power. Reduce the connected load and turn power on again.
- In case of momentary power overload such as caused by inrush current when a component is switched on or when a power amplifier reproduces a peak passage in the music, a current limiter becomes active to ensure safe use.
- When DC voltage is detected in the output due to an operation problem or when the output voltage exceeds the maximum rating, the output is switched off to protect connected components.

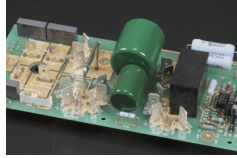

Assembly with protection circuitry

- When the temperature of the internal heat sink or power transformer becomes too high, the circuitry is automatically shut down.

Strong Power Supply With High-Efficiency Toroidal Transformer and Large Filtering Capacitors (47,000 μF x2)

The power transformer plays a vital role in any power supply. The PS-1220 uses a large toroidal type rated for 1500 VA. Toroidal power transformers have large-gauge copper wiring on a donut-shaped core, resulting in very low impedance and high efficiency.



Toroidal transformer

Total of Eight AC Outlets

Eight AC outlets on the rear panel of the unit provide ample capacity to connect for example a CD player, preamplifier, power amplifier, and other A/V components, up to the combined maximum rated power consumption (1200 VA for 230 V AC version or 1000 VA for 120 V AC version). The low output impedance of each outlet means that all operate under the same conditions, so there will be no difference in sound quality, regardless of which outlet is chosen.



Filtering capacitors

Front Panel

(The photograph shows the 230 V version.)

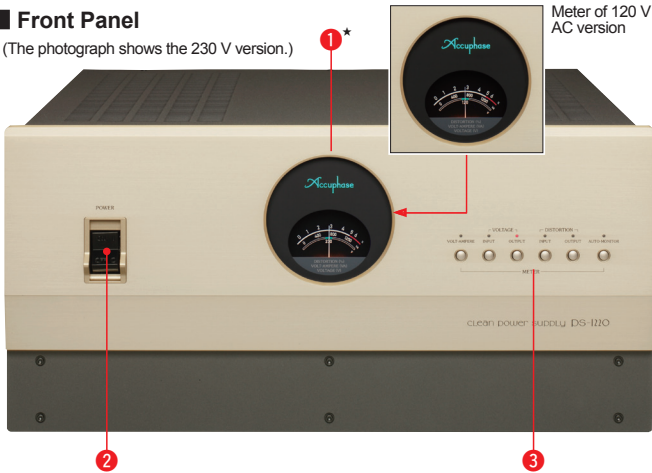

Meter of 120 V AC version

PS-1220 Meter (Power) Indication and Load

The power consumption of electrical equipment, as indicated on the equipment itself and in catalogs and other documentation according to legal requirements, is usually given in watts (W). This figure represents the so-called effective power. However, the actual power drawn by the equipment is larger than the effective power. This is called the apparent power which is calculated by multiplying the applied voltage (230 V or 120 V) with the actual current. The unit for apparent power is VA (Volt-Ampere).

Since the value shown by the meter of the PS-1220 is the apparent power, the reading will be higher than the power consumption (W) given in catalogs and specification sheets.

- The rated power limit of the PS-1220 is 1200 VA for the 230 V AC version and 1000 VA for the 120 V AC version. When deciding on equipment to be connected, select components so that the total remains within these limits, and check actual power consumption using the meter.
- In case of overload, the meter function selector LEDs flash. Reduce the load by reducing the number of connected components until the LEDs stop flashing and stay constantly lit.
- The power consumption of integrated amplifiers and power amplifiers varies considerably depending on the actual audio output. After connecting such equipment, perform playback and verify that power consumption does not exceed the maximum rating when peaks in the music are reproduced at high volume levels.

Rear Panel

(The photograph shows the 230 V version.)

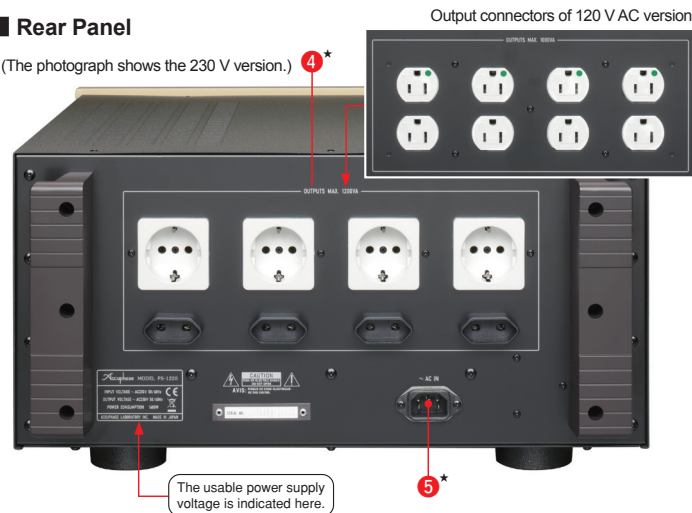

Output connectors of 120 V AC version

The usable power supply voltage is indicated here.

- Meter (Output power, input/output voltage, input/output distortion)*
- Power switch/circuit protector
- Meter operation selector buttons
VOLT AMPERE (VA) VOLTAGE INPUT/OUTPUT (V)
DISTORTION INPUT/OUTPUT (%) AUTO-MONITOR
- Output connectors (AC outlets)*
- AC power connector*

Remark

★ The 230 V AC and 120 V AC versions of the PS-1220 differ regarding meter voltage indication, AC output connector shape, supplied power cord, etc. Make sure that you have the correct version.



Caution

- * The PS-1220 is available in 230 V AC and 120 V AC versions. The actual allowable voltage is indicated next to the AC power connectors on the rear panel. Be sure to check this indication before using the PS-1220.
- * This product can be used only on a regular household AC circuit rated for 230 V or 120 V AC, 50/60 Hz. Using the product with portable AC generators, airplane or ship power generators or other types of power sources is not possible.
- * This product is designed to improve the quality of AC power supplied to audio or video components. Do not use it to power industrial type equipment or common household electrical appliances.
- * Do not use this unit for powering equipment where failure incurs a risk of injury or fatal accidents (medical equipment, aviation equipment, traffic control equipment, furnace and heating control equipment, safety devices, etc.). Accuphase will not be liable for any problem occurring due to use of the PS-1220 with the above type of equipment.

■ Supplied accessories: • AC power cord



ACCUPHASE LABORATORY, INC.

• Specifications and design subject to change without notice for improvements.

<http://www.accuphase.com/>

D1105Y PRINTED IN JAPAN 851-0203-00 (B1)