

# Accuphase

CLEAN POWER SUPPLY

## PS-550

- Input/output waveform display
- Output power meter
- Input/output voltage meter
- Input/output distortion meter
- 0.08% total harmonic distortion waveform shaping
- High-grade output voltage correction
- Numerous output terminals
- High-sensitivity protection circuitry
- Large high-efficiency toroidal transformer
- Large filtering capacitors





# A clean power source with revolutionary waveform shaping technology

The power supply delivers the energy your audio equipment uses for music playback. Accuphase's Clean Power Supply components provide a power source with minimum noise and distortion by utilizing a groundbreaking waveform shaping technology that compares the power supply's waveform to a reference waveform, then supplements insufficiencies and removes any excess misshaping. The results of waveform shaping are then observable in a new waveform display. The PS-550 delivers impressive improvements in audio quality, making it an essential supplement to fine audio equipment.

## Groundbreaking technology

### Clean output waveforms

Figure 1 shows the waveform for power and its harmonics supplied in a typical home. These typical power supply waveforms are distorted and contain unwanted harmonics. When these harmonics find their way into the audio equipment, they interfere with the audio signals and degrade the sound quality. Figure 2 shows the output waveform from the PS-550 and its harmonics. Third-order harmonics have been reduced from  $-40$  dB to  $-80$  dB. This is how the PS-550 significantly reduces harmonics in the output sine waves and minimize distortion.

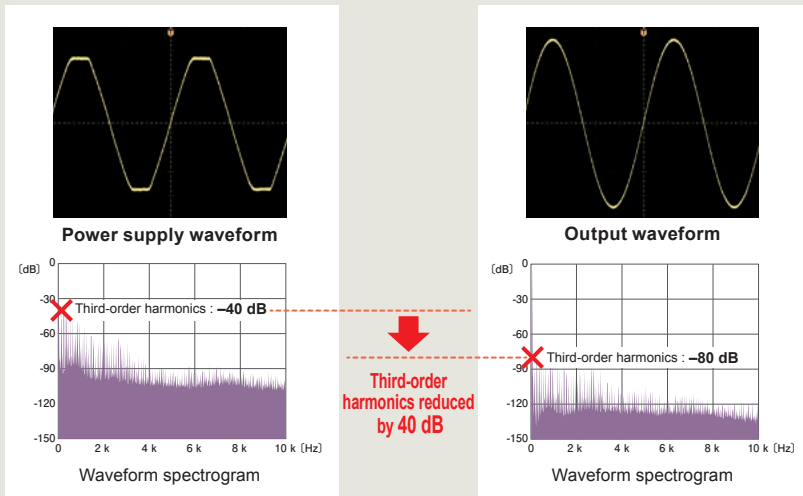
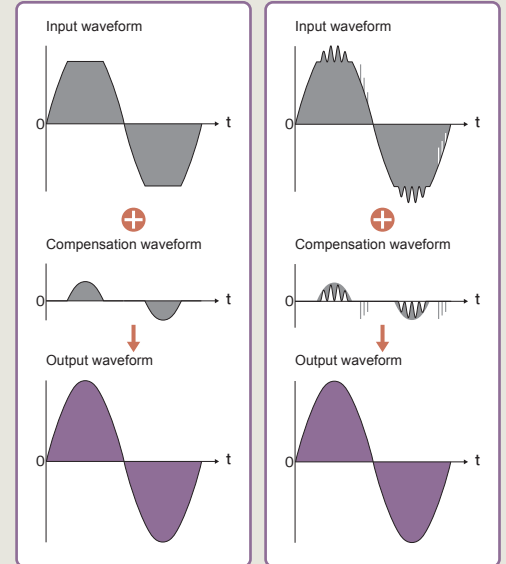

Fig. 1: Power supply in a typical home

Fig. 2: PS-550 output

### The waveform shaping process



(a) Shaping distorted waveforms (b) Shaping waveforms containing noise

The PS-550 creates an ideal waveform sine wave before a signal is received (reference waveform). It then produces a sine wave of the input waveform by comparing it to this reference waveform and compensating any insufficiencies while also removing any excess impurities.

### Three stages of noise elimination

The PS-550 features three stages of noise elimination. In the first stage, a line filter removes noise components from digital devices and other similar equipment. The second stage involves a shielded toroidal power transformer, which eliminates common mode noise. The third stage consists of a waveform correction amp, which uses waveform shaping to generate an extremely clean power supply.

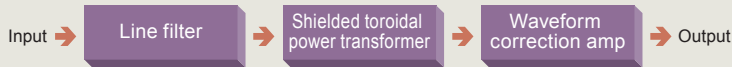

### Reference waveform generator

Shaping the ideal waveform requires a highly accurate reference waveform. The PS-550 detects the zero-cross point in the power supply to generate a square waveform, which is then sent through a two-stage band pass filter and a six-stage band elimination filter to generate a highly precise reference waveform free from harmonics.

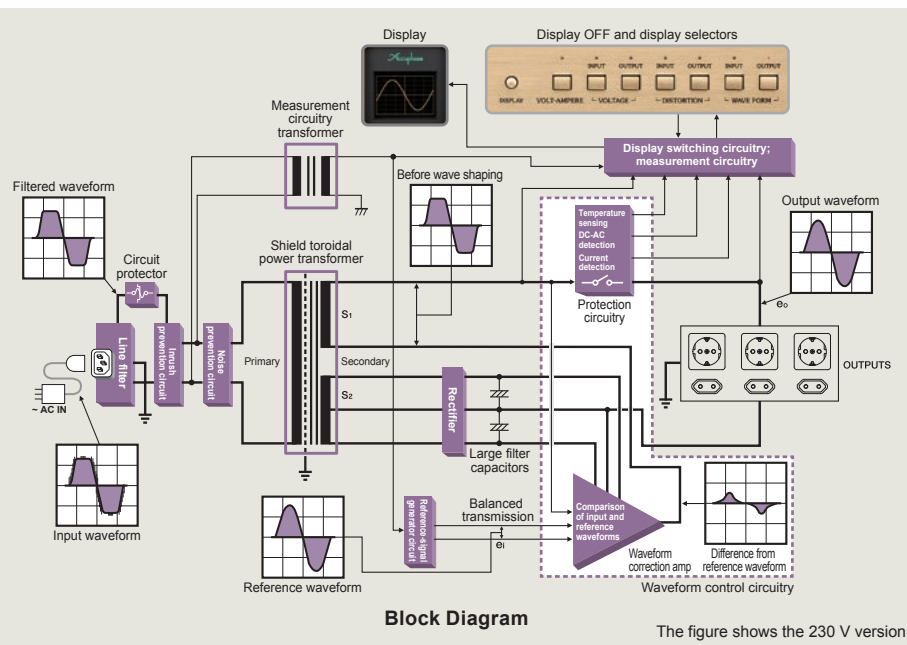

Block Diagram

The figure shows the 230 V version.

### Reference waveform generator

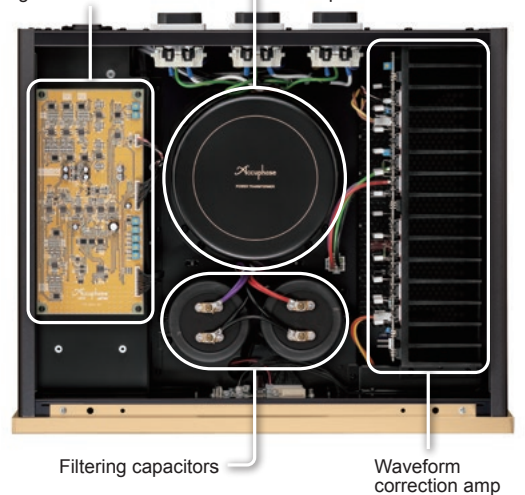

Filtering capacitors

Waveform correction amp

The photograph shows the 230 V version.

## Advanced features

- Output power meter .....①
- Input/output voltage meter .....②
- Input/output distortion meter .....③
- Input/output waveform display .....④
- 0.08% total harmonic distortion waveform shaping
- Output voltage correction
- Multiple output terminals
- High-sensitivity protection circuitry
- Large high-efficiency shielded toroidal power transformer
- Large filtering capacitors

### Waveform shaping to achieve high efficiency and low noise

Waveforms are shaped as pure AC with no conversion to DC, which helps improve efficiency. And because the PS-550 does not rely on oscillators, the risk of generating high-frequency noise has been eliminated.

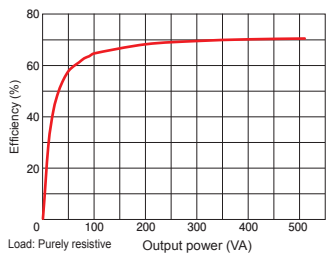

Output power/efficiency characteristics

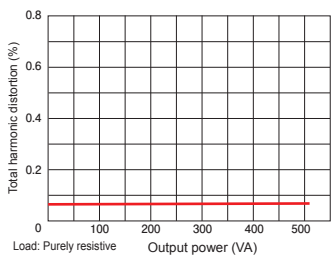

Output power - THD characteristics

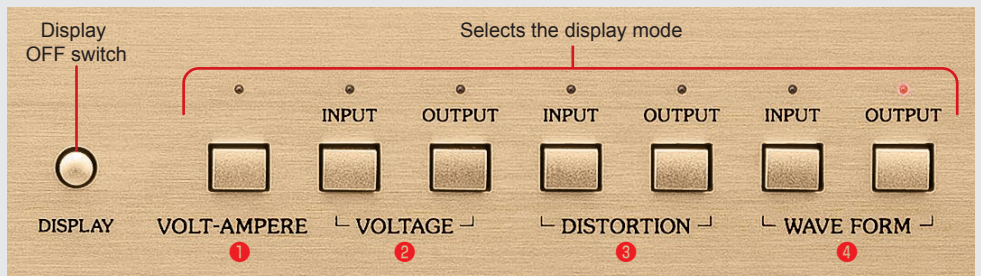

① Output power (VA)



② Input/output voltage (V)



③ Input/output distortion (%)

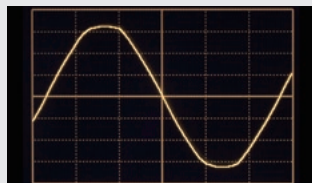

Input waveform

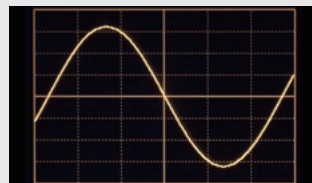

Output waveform

④

The display can show the following attributes.

- ① Output power (VA)
- ② Input/output voltage (V)
- ③ Input/output distortion (%)
- ④ Input/output waveform

The input/output waveform display shows the input power supply and output power supply waveforms.

\* The photograph shows the 230 V version.

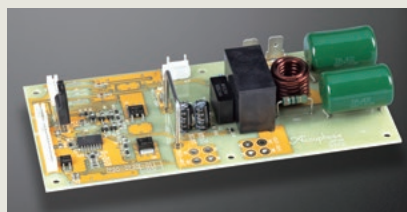

Protection circuitry protects the unit and all connected equipment if abnormalities should occur.

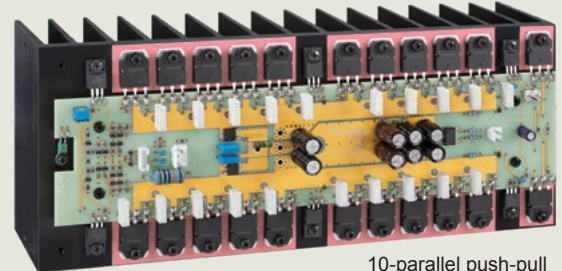

10-parallel push-pull output stage



The photograph shows the 230 V version.

## Advanced Features

### Robust power supply stage

The PS-550 features a strong power supply consisting of a large shielded toroidal power transformer and two large filtering capacitors (22,000  $\mu$ F/90 V).



Shielded toroidal power transformer



Filtering capacitors

### Elegant appearance

The aluminum side panels are finished to a high gloss and perfectly complement the champagne-colored front panel to create an exquisite look that will blend in seamlessly with any audio system.



### Multiple output terminals

The PS-550 is equipped with multiple output terminals to accommodate numerous audio equipment components.

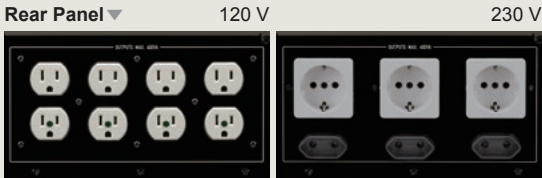

Rear Panel

120 V

230 V

### Compatible equipment

Though power consumption for electrical equipment is shown in watts (W), the VA (volt-ampere) of the system components is used to determine which units can be connected with the PS-550. The VA/W ratio is different for each piece of electrical equipment, but the VA value is generally 1.2–1.8 times the W value.

How to check

- Switch the display mode to the VOLT-AMPERE display and connect the equipment, making sure the total is less than 400 VA.
- The LED on the display selector will blink if the total exceeds 510 VA. Disconnect any equipment until the light turns steady.
- Since the VA level of integrated amplifiers and power amplifiers depends on the volume level, keep VA below 400 VA at maximum volume levels.

### Front Panel

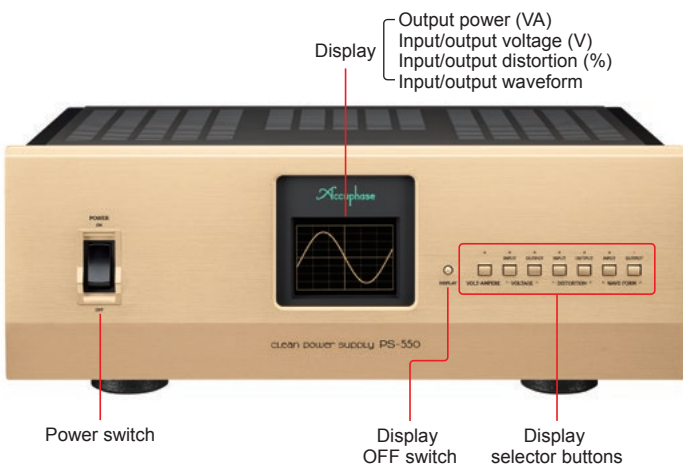

Display  
Output power (VA)  
Input/output voltage (V)  
Input/output distortion (%)  
Input/output waveform

Power switch

Display OFF switch

Display selector buttons

### Rear Panel (The photograph shows the 230 V version.)

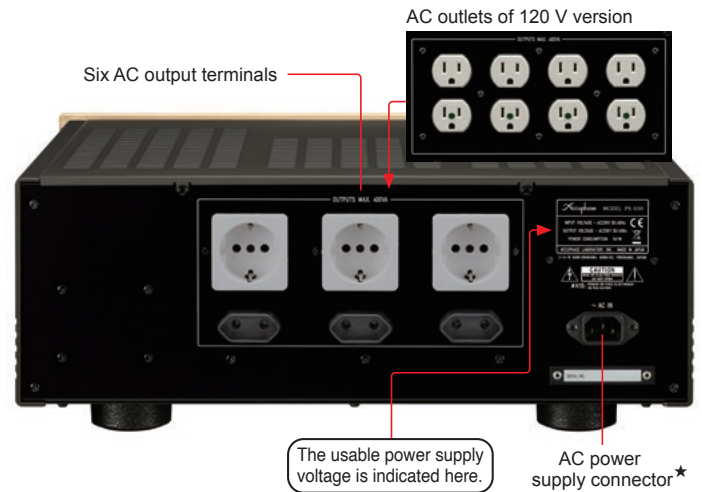

AC outlets of 120 V version

Six AC output terminals

The usable power supply voltage is indicated here.

AC power supply connector\*

## PS-550 Guaranteed Specifications

Rated Output Capacity	400 VA (continuous)	
Rated Output Voltage	AC 120 V $\pm$ 1.5 V	AC 230 V $\pm$ 3.0 V
Rated Output Current	3.4 A	1.8 A
Output Frequency	50 Hz or 60 Hz (identical to input frequency)	
Output Waveform THD	0.08% or less	
Rated Input Voltage	AC 120 V $\pm$ 10%	AC 230 V $\pm$ 10%
Input Frequency	50 Hz or 60 Hz	
No-load Power Consumption	27 W	43 W
Cooling Principle	Natural air cooling	

Display	VOLT-AMPERE	0–510 VA		
	VOLTAGE INPUT / OUTPUT (green zone range)	AC 120 V $\pm$ 10%		AC 230 V $\pm$ 10%
	DISTORTION INPUT / OUTPUT	0–6%		
	WAVE FORM INPUT / OUTPUT	-		
Mass	Maximum Dimensions [Width × Height × Dept]	465 mm × 181 mm × 385 mm (18.3" (7.2") (15.2")	465 mm × 181 mm × 396 mm (18.3" (7.2") (15.6")	
	Net	24.4 kg (53.8 lbs.)	24.0 kg (53.0 lbs.)	
	In shipping carton	31 kg (68.4 lbs.)		

### Note

\* The 230 V AC and 120 V AC versions of the PS-550 differ regarding meter voltage indication, AC output connector shape, supplied power cord, etc. Make sure that you have the correct version.



Caution

- \* The PS-550 is available in 230 V AC and 120 V AC versions. The actual allowable voltage is indicated next to the AC power connectors on the rear panel. Be sure to check this indication before using the PS-550.
- \* This product can be used only on a regular household AC circuit rated for 230 V or 120 V AC, 50/60 Hz. Using the product with portable AC generators, airplane or ship power generators or other types of power sources is not possible.
- \* This product is designed to improve the quality of AC power supplied to audio or video components. Do not use it to power industrial type equipment or common household electrical appliances.
- \* Do not use this unit for powering equipment where failure incurs a risk of injury or fatal accidents (medical equipment, aviation equipment, traffic control equipment, furnace and heating control equipment, safety devices, etc.). Accuphase will not be liable for any problem occurring due to use of the PS-550 with the above type of equipment.

Supplied accessory  
● AC power cord



ACCUPHASE LABORATORY, INC.