

# Precision Stereo Pre-Amplifier C-2850



Accuphase Laboratory, Inc.

1

C-2800 was launched as the first AAVA (Accuphase Analog Vari-gain Amplifier) pre-amplifier in 2002. Following C-2800, Accuphase put C-2810 and C-2820 on the market in 2006 and 2011.

C-2850 is the 4<sup>th</sup> generation high-end pre-amplifier descended from brilliant C-2800 series.

C-2850's technical feature is 20 % lower noise performance than C-2820 achieved by the improved AAVA volume control principle.

## Dimensions and Weight

- Same dimensions as the former model
  - Width 477 mm
  - Height 156 mm
  - Depth 412 mm
  - Weight 24.5 kg

0.8kg heavier than the former model

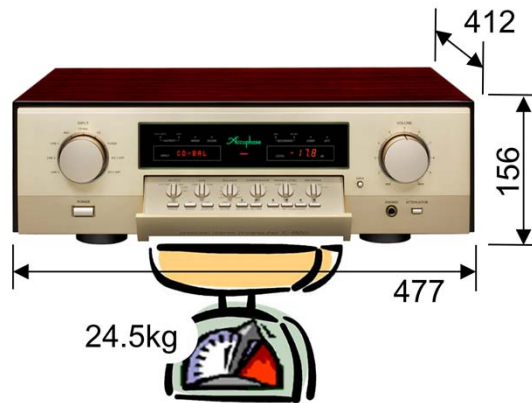

Accuphase Laboratory, Inc.

2

The size of C-2850 is as same as the former model C-2820.

However C-2850 is 0.8kg heavier than C-2820 as the power transformer is reinforced.

# Front display

- Easy to see large “Volume display”



Accuphase Laboratory, Inc.

3

C-2850 has refined the volume display from the former model.

C-2850 newly applies 7-segment LED from previous dot matrix LED as well, this new LED allows C-2850 to achieve much better visibility with above improvements.

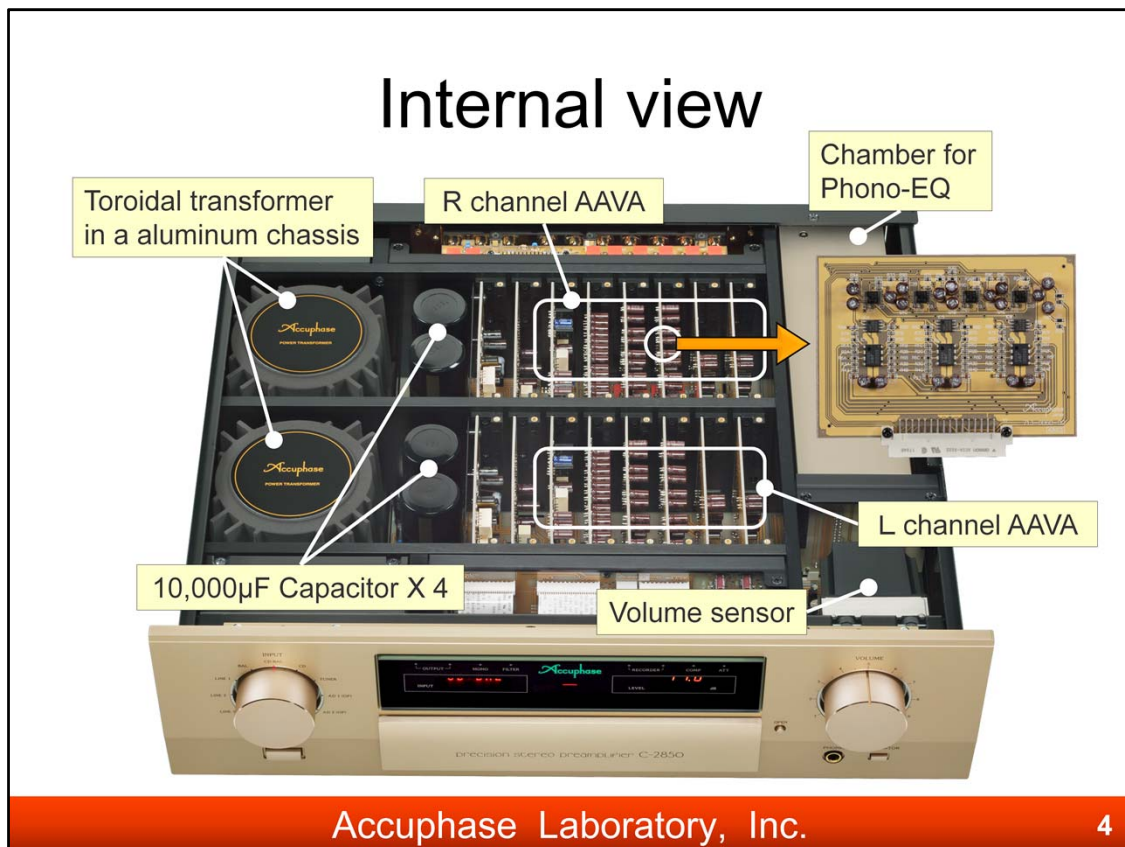

C-2850 inherits C-2820's internal construction as it is.

C-2850 has dual monophonic layout with strong power supply comes from large Troidal power transformer and 4 pieces of special made 10,000 $\mu$ F capacitors.

Amplifier circuits are deployed on Glass Cloth Fluorocarbon Resin(commonly known as "Teflon") PC-Board by Fully Modular Construction which has beneficial effects on the radiation performance and the ease of maintenance.

## Custom-made volume sensor mechanism

- Distinguished operation feeling
- Ultimate reliability

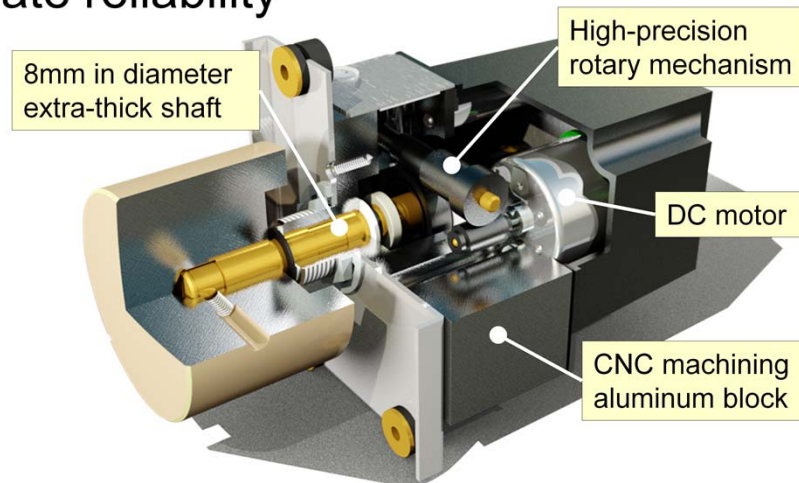

Accuphase Laboratory, Inc.

5

The music signal does not pass volume mechanism in AAVA. It is just a position sensor to set and adjust the volume level.

However, the feeling of the volume knob is very important for audiophiles.

Therefore, the volume sensor mechanism with splendid operation feeling needed to be developed in C-2800's project.

It is built with CNC machining aluminum block, extra-thick shaft and more.

C-2850 utilizes the same volume sensor mechanism which was developed for C-2820.

## Operating sound reduction

- Volume sensor mechanism is floating from the chassis.

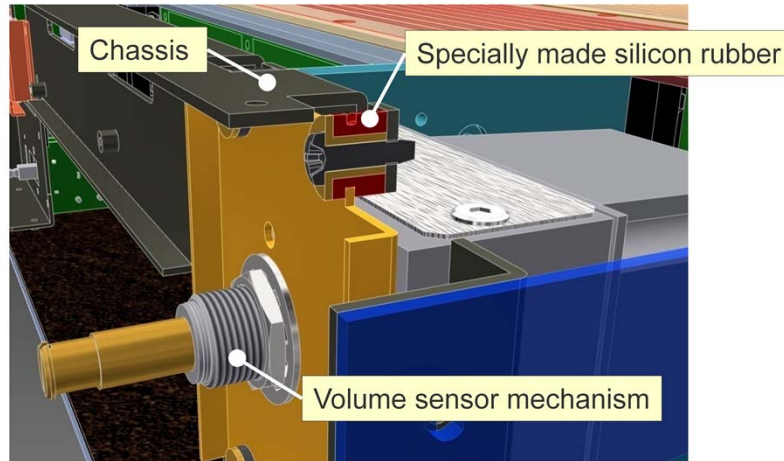

Accuphase Laboratory, Inc.

6

Former model C-2820 had a small operating noise because the motor's vibration came down to the chassis when the volume was controlled with a remote commander.

C-2850 succeeds in reducing such an operating noise by making the volume sensor mechanism float from the chassis to block off the vibration with specially made silicon rubbers.

# Ultra Low Noise

- 20% lower than former model
  - S/N ratio: 111dB guarantee
  - Input referenced noise: -123dBV guarantee

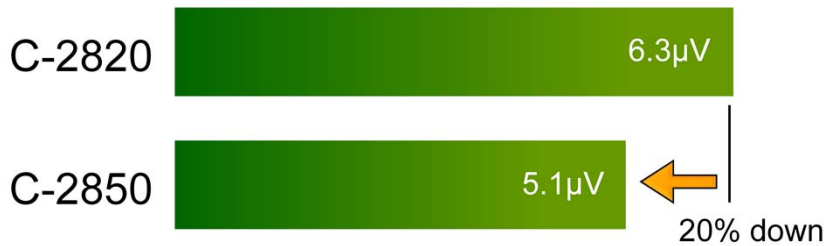

Actual output noise graph @volume maximum

Accuphase Laboratory, Inc.

7

The former model C-2820 has excellent noise performance, however, the output noise voltage of C-2850 is 20% lower than even C-2820.

C-2850 guarantees,  
SN ratio: 111dB  
Input referenced noise: -123dBV

# Technology for ultra low noise

- Improvement of AAVA
  - Fourth paralleled largest unit, paralleled second largest unit in “V to I” converter

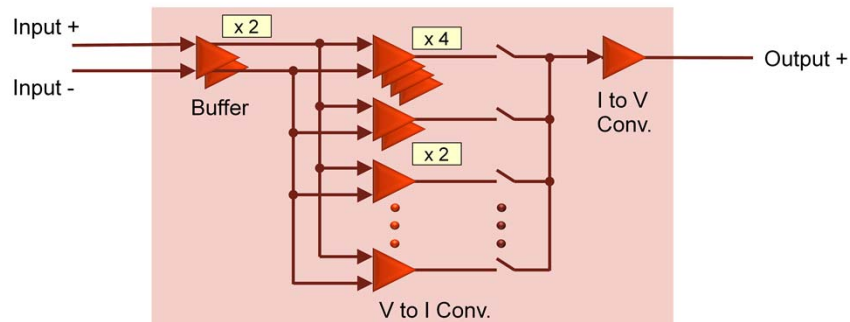

Block Diagram of AAVA

Accuphase Laboratory, Inc.

8

The AAVA (Accuphase Analog Vari-gain Amplifier) is a volume control principle that eliminates all variable resistors from the signal path. It is totally different from any others.

The AAVA module in C-2850 achieves low noise by the fourth paralleled largest unit and the paralleled second largest unit in “V to I” converters.

\* The AAVA module in the former model C-2820 has paralleled the largest two units in “V to I” converters.



# Technology for high reliability

- Thermal dispersion

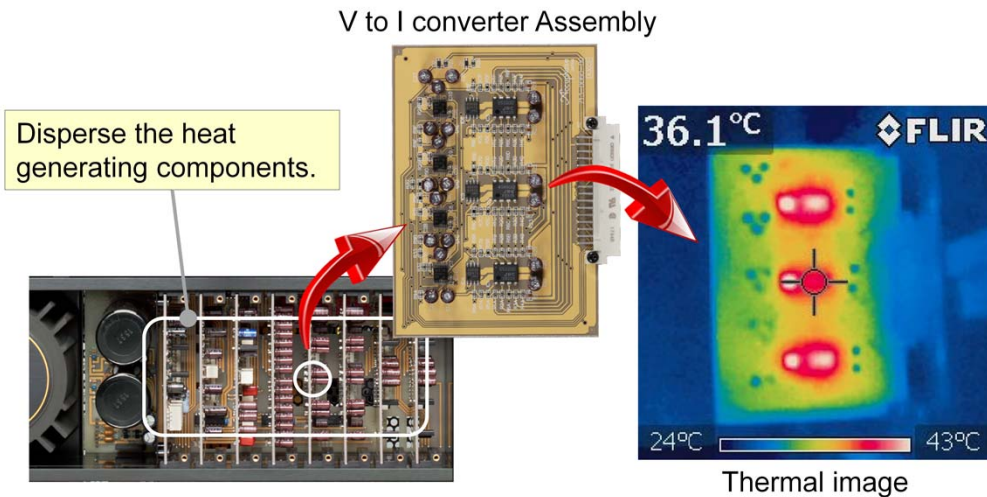

Accuphase Laboratory, Inc.

9

The internal temperature of unit has a big effect on product lifetime and reliability.

To avoid the heat concentration at specific modules, C-2850 decentralizes the heat-generating components inside the units, and realizes an epoch-making thermal dispersion effects.

## Further more ...

- Function memory
  - AD1, AD2 input: Memorize Phono EQ settings individually

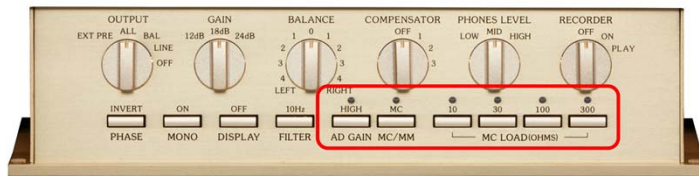

- High-quality remote commander

Accuphase Laboratory, Inc.

10

AD1 & AD2 inputs are available only when the dedicated Phono Equalizer Unit AD 2800 series installed.

C-2850 is able to memorize the phono equalizer settings at each AD1 or AD2 input as an individual case.

An elegant high-quality remote commander is supplied with.

# Dedicated Phono Equalizer Unit AD-2850



Accuphase Laboratory, Inc.

11

With the release of C-2850, Accuphase renews the dedicated Phono Equalizer Unit AD-2850 as well.

AD-2850 is the 4<sup>th</sup> generation dedicated Phono Equalizer Unit.

AD-2850 technical features are 10% lower noise performance than the former model AD-2820 and low RIAA equalization error achieved by Differential RIAA Equalizer configuration.

# Functions

- Gain switchable
  - MC: 60dB, MC: 70dB
  - MM: 30dB, MM: 40dB
- Input impedance selectable
  - MC: 10, 30, 100, 300 ohm
  - MM: 47k ohm

Function buttons on C-2850 sub panel



Accuphase Laboratory, Inc.

12

AD-2850 is the function-rich Phono Equalizer Unit.

All functions are able to be controlled with the function buttons on the sub panel of pre-amplifier installing the unit.

# Ultra Low Noise

- 10% lower than former model
  - @ MC60dB, MC70dB, MM30dB, MM40dB



Actual output noise graph @MC60dB

AD-2850 shows ultra low noise performance. Its output noise voltage is 10% lower than the former model AD-2820.

## Block diagram

- Differential RIAA equalizer configuration
  - Low RIAA equalization errors:  $\pm 0.2\text{dB}$ (MC60/70)

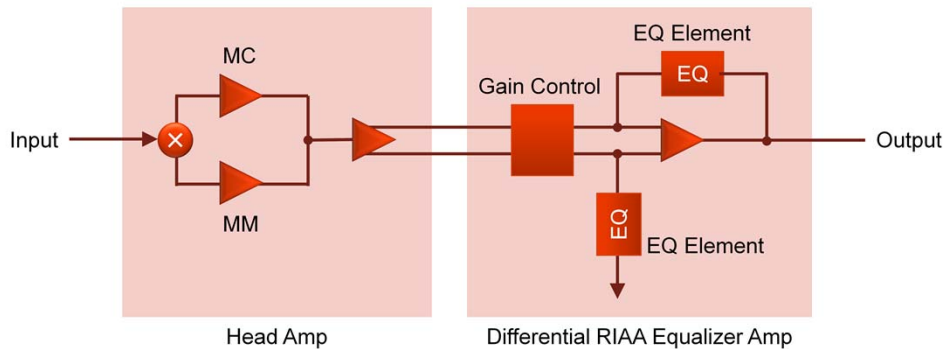

Accuphase Laboratory, Inc.

14

AD-2850 has quite unique configurations, as it consists of two amplifiers, Head Amp and Differential RIAA Equalizer Amp.

The first stage of Head Amp features separate input circuitry, it switches between bipolar-transistor for MC type cartridges and junction-FET for MM type cartridges, and realizes ultra low noise performance.

Differential RIAA Equalizer Amp is balanced input EQ amplifier, it is designed to provide low RIAA equalization errors when changing the AD GAIN value.

# Backward compatibility

- Available model
  - C-2800, C-2810, C-2820, C-2850
  - C-2400, C-2410, C-2420
  - C-290, C-290V



Accuphase Laboratory, Inc.

15

AD-2850 is supported by not only C-2850 but following models for backward compatibility.

- C-2820, C-2810, C-2800
- C-2420, C-2410, C-2400
- C-290V, C-290

Remarks;

1. MC LOAD impedance  $300\Omega$  is not available for any models other than C-2850, C-2820 and C-2420 due to no impedance selector button.
2. For any models other than C-2850, C-2820 and C-2420, AD GAIN value should be unified into MC: 60/70dB & MM: 30dB/40dB different from the inscribed values on products.